

**Introduction**



Microswitches of MK series have been developed in order to add new features to traditional and tested microswitches of Pizzato Elettrica (cross-reference at page 7/50). These new products have been designed with shapes and fixing perfectly interchangeable with the previous ones and with various additional functions useful to extend the application field.

The main innovation of this series is the tripping device modern and evolved, with qualitative features higher than solutions present on the market.

The electrical contact on new microswitch has been realized with higher reliability technology, thanks to the double and redundant shape, and has the possibility to carry out operations with positive opening.

The housing of the new microswitch provides the possibility to seat gaskets in order to seal the device against fine dusts or liquids up to IP65 degree.

Fastening terminals of conductors are more practical and allow the fixing of different diameter cables or the possibility to choose different bends of faston contacts. For high quantity it's possible to supply the microswitch only with the contact NO or NC, in order to minimize purchase costs.

**Contact block reliability**

In the following table we refer to the typical microswitch contact structure (type A) normally used in the industry, compared with the innovative solution that Pizzato Elettrica uses in new MK series microswitches: movable contact with single interruption and double contacts (type B).

As you can see from the table below, this last structure (type B) offers half of the contact resistance ( R ) than the simple mobile contact (type A) and a lower probability of failure ( fe ).

In fact, defined x the probability of a commutation failure of a single interruption, it results that in the type A the failure probability  $fe=x$ , in the type B the probability  $fe= x^2$ . This means that if in a certain situation the failure probability x is equal, for instance, to  $1 \times 10^{-4}$  (1 failed interruption every 10.000), we will have:

- in type A one failed commutation every 10.000
- in type B one failed commutation every 100.000.000

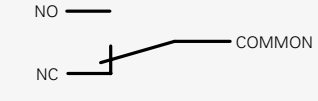
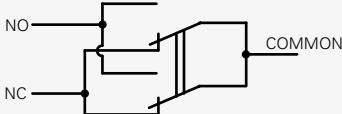
Type	Figure	Description	Contact resistance R	Probability of failure fe
A Common microswitch		Contacts with single interruption	$R=R_c$	$fe=x$
B Pizzato microswitch MK series		Contacts with single interruption and double contacts	$R=R_c/2$	$fe \cong x^2$

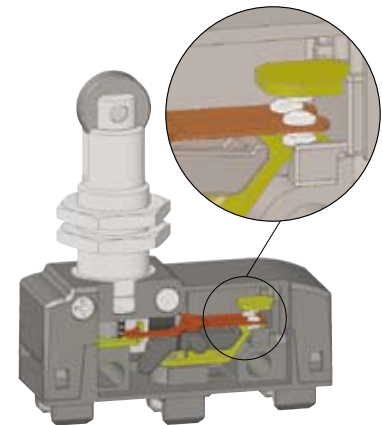

**Extended temperature range**

**-40°C**

On request, on new MK series are available the versions with extended temperature range. Differently from standard MK microswitches with temperature range from +85 C° to -25 C°, these special versions can be used in places where the ambient temperature changes from +85 C° to -40 °C.

They can be installed inside cold stores, sterilizers or other equipment with very low ambient temperature. Special materials that have been used to realize these versions, maintain unchanged their features also in these conditions, widening the installation possibilities.

**Microswitches for safety applications**

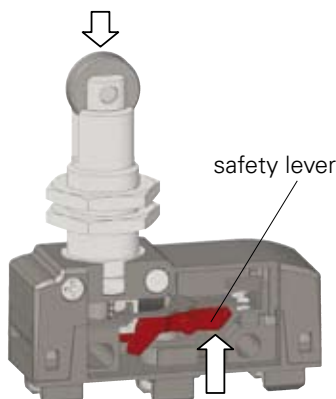

All microswitches that have the symbol  $\ominus$  beside the code are with positive opening, therefore suitable for safety applications.

These microswitches are provided with a rigid connection between push button and NC contacts, which are opened by force through a strong/sturdy internal safety lever.

The positive opening has been realised in conformity with the standard IEC 60947-5-1, enclosure K, therefore these microswitches are suitable for the installation for people's protection.

### Protection degree IP65

By installing microswitches MK ●●2●● with terminal covers VF MKC●22 or terminal covers VF MKC●23, it's possible to obtain a microswitch fully dust proof and waterproof.

Thanks to special rubber gaskets anti-oil, we achieve the protection degree IP65.

For application with high presence of dirtiness, are available also versions with double gasket in the push button ( internal + external). ex. MK ●●2●12 or MK ●●2●13.

- Gaskets
- Microswitch: MKV12D12
- Terminal cover: VF MKCV22

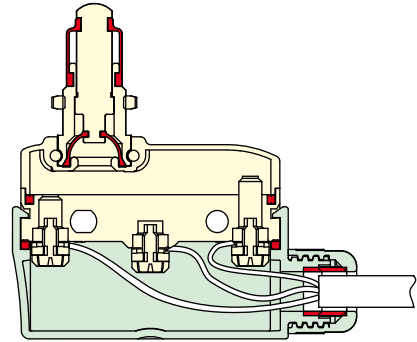

### Clamping screw plates for different diameter cables (MK V●)



These clamping screw plates have a particular "roofing tile" structure and are connected loosely to the clamping screw. In this way, during the wires fixing, the clamping screw plate is able to suit to cables of different diameter (see picture) and tends to tighten the wires toward the screw instead of permitting them to escape towards the outside.

### Terminal covers with wire trap cable gland side by side

New terminal covers supplied with wire trap cable gland are provided for the protection degree up to IP65.

These terminal covers are snap-in assembled and they have small dimensions in the microswitch profile, it's possible to install them also on microswitches fixed side by side. See page 2/136.

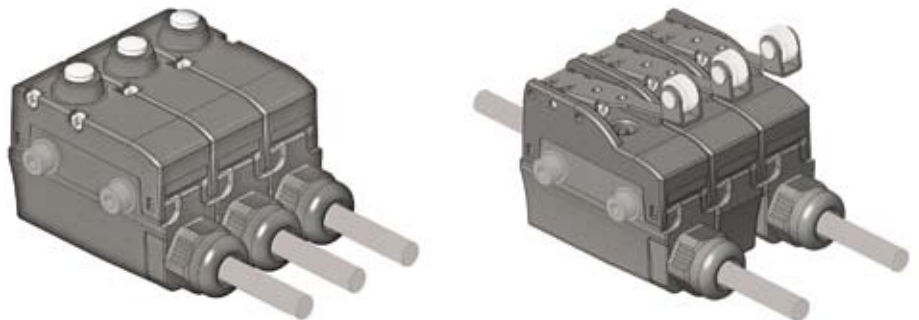

### Rotating actuators



Thanks to the new lateral fixing system patented, it's possible to rotate the roller of microswitches MK ●●●15 and MK ●●●17 in 90° steps.

The lateral fixing allows to disconnect the actuator from the body also when the actuator is already fixed to the racket. The flexibility of the product allows also to unify items on stock for applications that require roller both longitudinal or transversal.

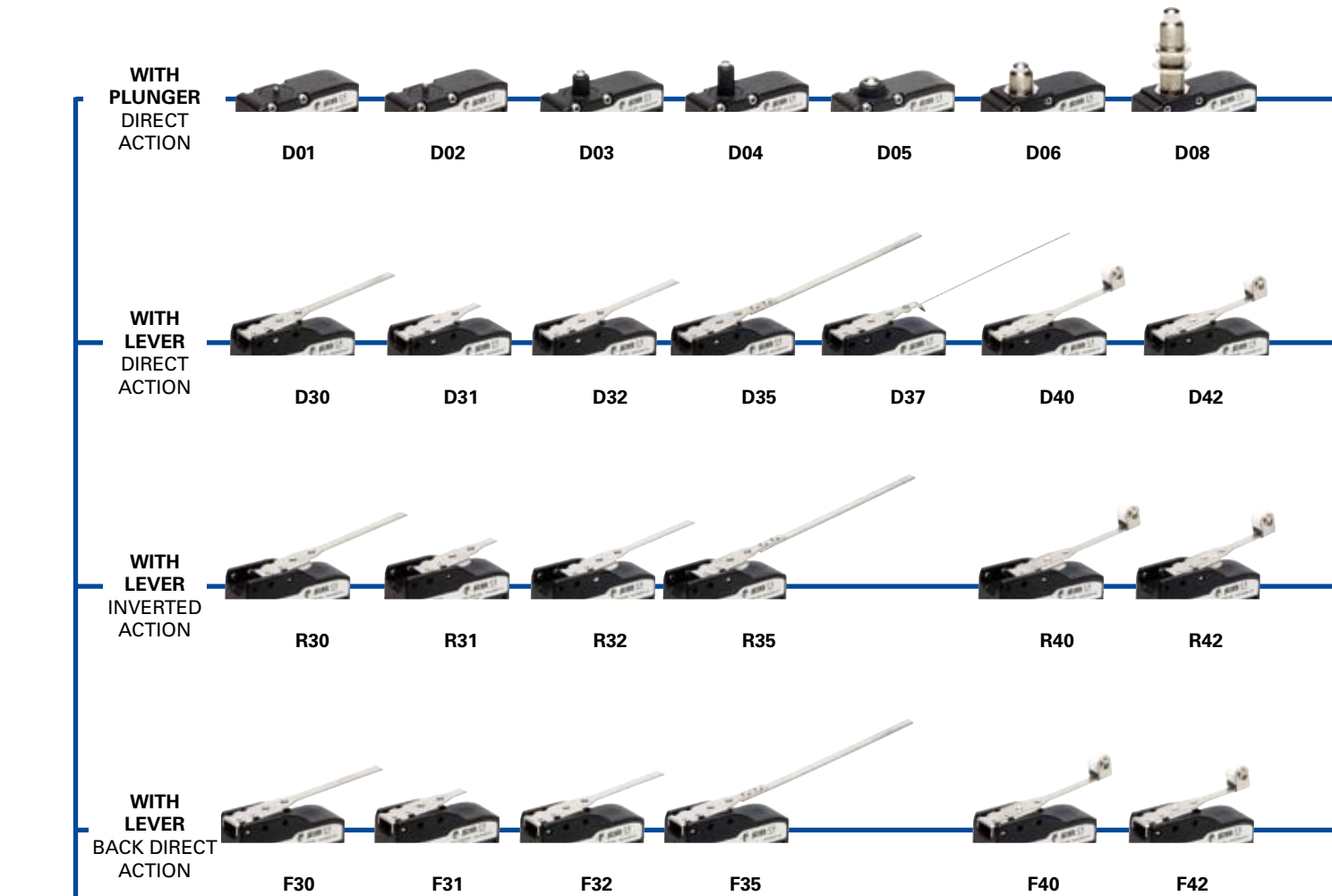

**ACTUATORS**

—●— product option  
 —▶— accessory sold separately



**TERMINALS**

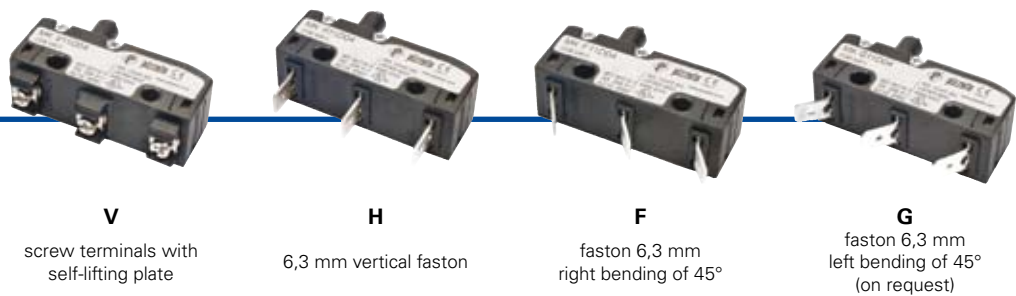



D09

D10

D12  
external rubber gasket

D13  
external rubber gasket

D15

D17

D18

D19



D45

D46

D47

D53

D59

D49



R45

R46

R47

R53

R59

R60



F45

F46

F47

F53

F59

F49

### Code structure

**Attention!** The feasibility of a code number does not mean the effective availability of a product. Please contact our sales office.

article options  
**MK V12D40-GR16T6**

Terminals type	
<b>V</b>	screw terminals with self-lifting late
<b>H</b>	vertical faston terminals
<b>F</b>	with faston, right bending of 45°
<b>G</b>	with faston, left bending of 45° (on request)

Contact block	
<b>1</b>	1NO+1NC, snap action
<b>2</b>	1NO, snap action (on request)
<b>3</b>	1NC, snap action (on request)

Max protection degree	
<b>1</b>	IP40 (with protection)
<b>2</b>	IP65 (with protection)

Actuation type	
<b>D</b>	direct action
<b>R</b>	inverted action
<b>F</b>	back direct action

Ambient temperature	
	-25°C ... +85°C (standard)
<b>T6</b>	-40°C ... +85°C

Suffix	
	no suffix (standard)
<b>R16</b>	Ø 9,5x4 mm metal roller (for actuator 40, 42, 45, 47, 53, 59)
<b>R10</b>	Ø 9,8x8,4 mm polymer roller (for actuator 40, 42, 45, 53)

Contacts type	
	silver contacts (standard)
<b>G</b>	silver contacts gold plated 1 µm

Actuator	
<b>01</b>	with pin
<b>02</b>	with pin
<b>03</b>	with small push button
<b>..</b>	.....



### Main data

- Polymer housing
- High reliability contacts
- Protection degree IP20, IP40 or IP65
- 4 terminal types available
- 47 actuators available
- Versions with positive opening ⊕
- Silver contacts gold plated versions
- Terminal covers with wire trap cable gland
- Mechanically interchangeable with previous products (see cross reference on page 7/50)

### Markings and quality marks:

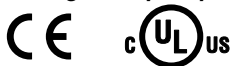

Approval UL: E131787

### Technical data

#### Housing

Made of glass-reinforced polymer, self-extinguishing, shock-proof thermoplastic resin.

Protection degree: IP20 (with protection VF C01 - VF C03)  
IP40 (with protection VF MKC•1• - VF C02)  
IP65 (with protection VF MKC•22 - VF MKC•23)  
according to EN 60529

#### General data

Ambient temperature: from -25°C to +85°C  
Max actuation frequency: 3600 operations cycles<sup>1</sup>/hour  
Mechanical endurance: 10 million operations cycles<sup>1</sup>  
Driving torque for installation: see pages 7/1-7/10  
(1) One operation cycle means two movements, one to close and one to open contacts, as foreseen by EN 60947-5-1 standard.

#### Cross section of the conductors (flexible copper wire)

MK series:	min.	1 x 0,34 mm <sup>2</sup>	(1 x AWG 22)
	max.	2 x 1,5 mm <sup>2</sup>	(2 x AWG 16)

#### In conformity with standards:

IEC 60947-5-1, EN 60947-5-1, IEC 60529, EN 60529.

#### Approvals:

UL 508

#### In conformity with requirements requested by:

Low Voltage Directive 2006/95/EC, Machinery Directive 2006/42/EC and Electromagnetic Compatibility 2004/108/EC.

#### Positive contact opening in conformity with standards:

IEC 60947-5-1, EN 60947-5-1, EN 60947-5-1, VDE 0660-206.

### Installation for safety applications:

Use only switches marked with the symbol ⊕. The safety circuit must always be connected with the **NC contacts** (normally closed contacts) as stated in the **standard EN 60947-5-1, encl. K, par. 2**. The switch must be actuated with **at least up to the positive opening travel (FAP)** near the code article. The switch must be actuated **at least with the positive opening force (CAP)**, near the code article.

⚠ **If not expressly indicated in this chapter, for the right installation and the correct utilization of all articles see requirements indicated from page 7/1 to page 7/10.**

#### Electrical data

Thermal current (I <sub>th</sub> ):	16 A
Rated insulation voltage (U <sub>i</sub> ):	250 Vac 300 Vdc
Rated impulse withstand voltage (U <sub>imp</sub> ):	4 kV
Conditional short circuit current:	1000 A according to EN 60947-5-1
Protection against short circuits:	fuse 10 A 500 V type gG
Pollution degree:	3
Dielectric strength	2000 Vac/min.

#### Utilization categories

Alternate current: AC15 (50 ... 60 Hz)			
U <sub>e</sub> (V)	250	120	
I <sub>e</sub> (A)	6	6	
Direct current: DC13			
U <sub>e</sub> (V)	24	125	250
I <sub>e</sub> (A)	5	0,6	0,3

### Data type approved by UL

Utilization categories Q300 (69 VA, 125-250 Vdc)  
A300 (720 VA, 120-300 Vac)

In conformity with standard: UL 508

Please contact our technical service for the list of approved products.



### Terminals outline dimension

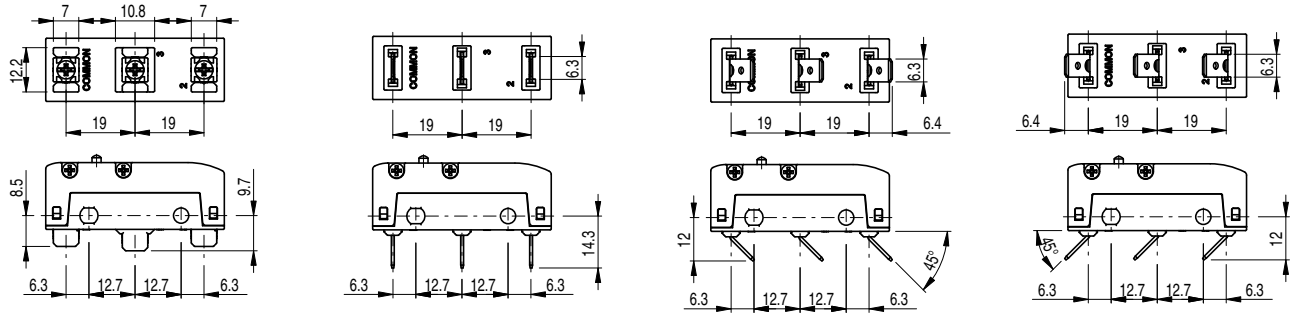

Screw terminals **V** with plate

Vertical faston **H** terminals

faston terminals **F**, right bending

faston terminals **G**, left bending (on request)

Note: H vertical faston terminals can be bent according to one's installation requirements.

We recommend to bend the faston with an angle not higher than 45° and to carry out this operation no more than 5 times.

### Wire diagram

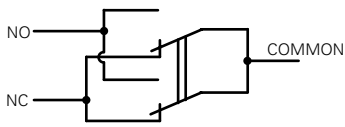

Contacts with single interruption and double contacts

With direct and back direct action (F, D)

With inverted action (R)

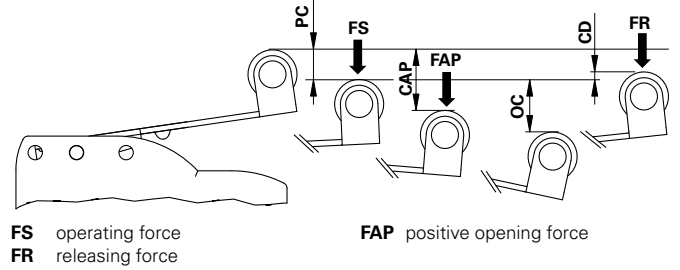
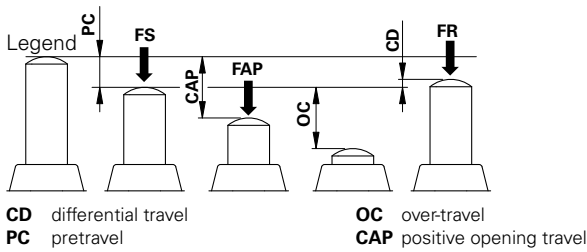
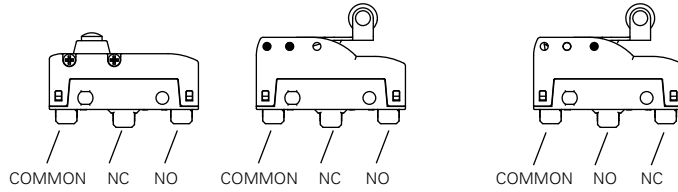

### Microswitches with direct action

10 pcs packs

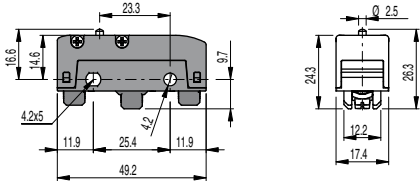
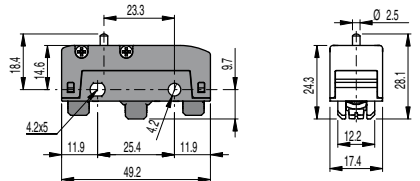
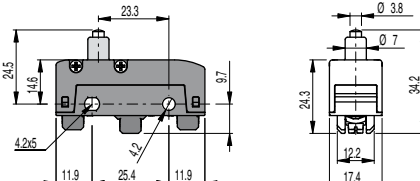
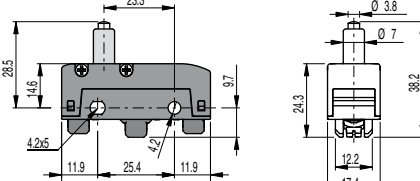
	
<p><b>MK V11D01</b> 1NO+1NC PC 0,5 mm FS 4 N OC 1,5 mm FR 3 N CD 0,05 mm</p>	<p><b>MK V11D02</b> 1NO+1NC PC 0,5 mm FS 4 N OC 2 mm FR 3 N CD 0,05 mm</p>
Max and min. speed page 7/8 - type 1	
	
<p><b>MK V11D03</b> 1NO+1NC PC 0,5 mm FS 4 N OC 2 mm FR 3 N CD 0,05 mm</p>	<p><b>MK V11D04</b> 1NO+1NC PC 0,5 mm FS 4 N OC 2 mm FR 3 N CD 0,05 mm</p>
Max and min. speed page 7/8 - type 1	

Items with code on the green background are available in stock



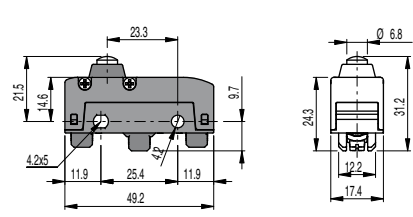

<b>MK V11D05</b> → 1NO+1NC	PC	0,5 mm	FS	4 N
	OC	2 mm	FR	3 N
	CD	0,05 mm	FAP	20 N
	CAP	2,2 mm		

Max and min. speed page 7/8 - type 1

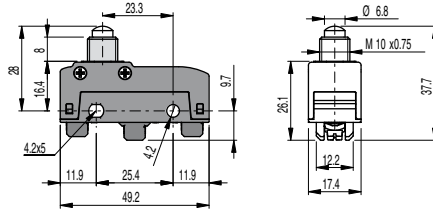

<b>MK V11D06</b> → 1NO+1NC	PC	0,5 mm	FS	4 N
	OC	3 mm	FR	3 N
	CD	0,05 mm	FAP	20 N
	CAP	2,2 mm		

Max and min. speed page 7/8 - type 1

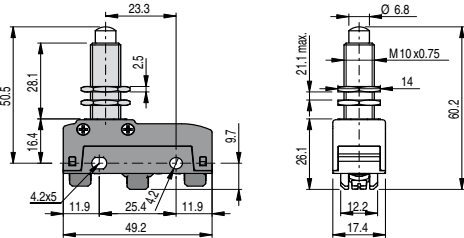

<b>MK V11D08</b> → 1NO+1NC	PC	0,5 mm	FS	4 N
	OC	5,5 mm	FR	3 N
	CD	0,05 mm	FAP	20 N
	CAP	2,2 mm		

Max and min. speed page 7/8 - type 1

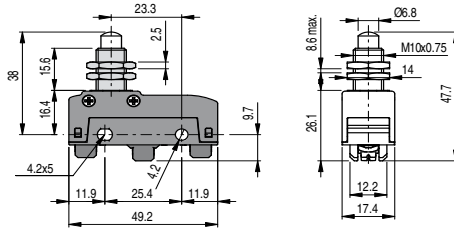

<b>MK V11D09</b> → 1NO+1NC	PC	0,5 mm	FS	4 N
	OC	5,5 mm	FR	3 N
	CD	0,05 mm	FAP	20 N
	CAP	2,2 mm		

Max and min. speed page 7/8 - type 1

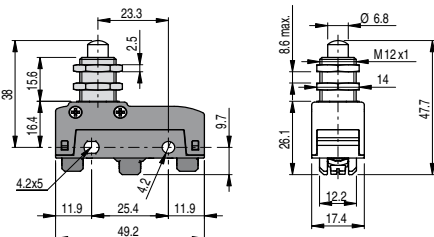

<b>MK V11D10</b> → 1NO+1NC	PC	0,5 mm	FS	4 N
	OC	5,5 mm	FR	3 N
	CD	0,05 mm	FAP	20 N
	CAP	2,2 mm		

Max and min. speed page 7/8 - type 1

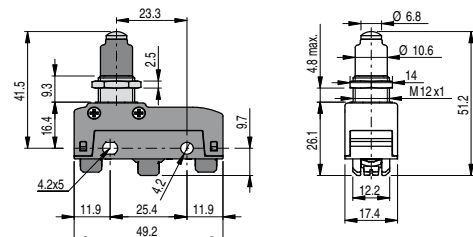

<b>MK V11D12</b> → 1NO+1NC	PC	0,5 mm	FS	4,5 N
	OC	5,5 mm	FR	3 N
	CD	0,05 mm	FAP	20 N
	CAP	2,2 mm		

Max and min. speed page 7/8 - type 1

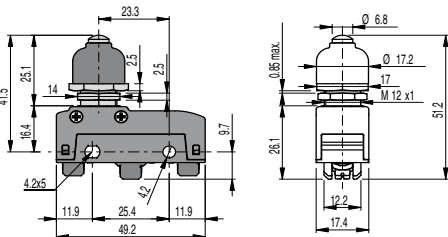

<b>MK V11D13</b> → 1NO+1NC	PC	0,6 mm	FS	6 N
	OC	5,4 mm	FR	4 N
	CD	0,05 mm	FAP	20 N
	CAP	2,2 mm		

Max and min. speed page 7/8 - type 1

Fixed only by threaded head

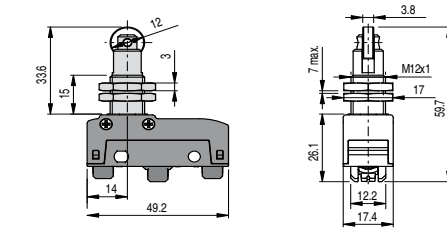

<b>MK V11D15</b> → 1NO+1NC	PC	0,5 mm	FS	4 N
	OC	5,5 mm	FR	3 N
	CD	0,05 mm	FAP	20 N
	CAP	2,2 mm		

Max and min. speed page 7/8 - type 2

Fixed only by threaded head

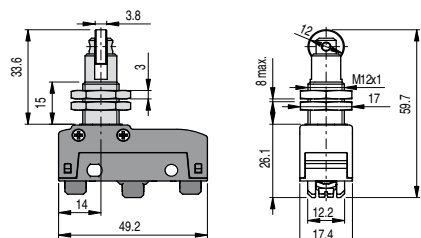

<b>MK V11D17</b> → 1NO+1NC	PC	0,5 mm	FS	4 N
	OC	5,5 mm	FR	3 N
	CD	0,05 mm	FAP	20 N
	CAP	2,2 mm		

Max and min. speed page 7/8 - type 2

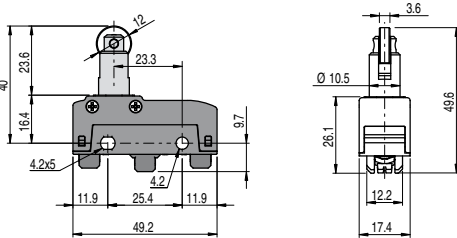

<b>MK V11D18</b> → 1NO+1NC	PC	0,5 mm	FS	4 N
	OC	5,5 mm	FR	3 N
	CD	0,05 mm	FAP	20 N
	CAP	2,2 mm		

Max and min. speed page 7/8 - type 2

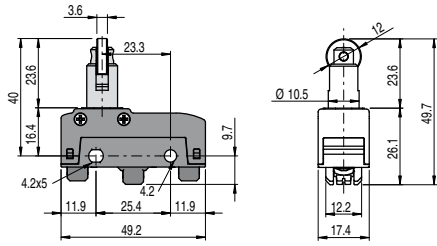

<b>MK V11D19</b>	1NO+1NC	PC 0,5 mm	FS 4 N
		OC 5,5 mm	FR 3 N.
		CD 0,05 mm	FAP 20 N
		CAP 2,2 mm	

Max and min. speed page 7/8 - type 2

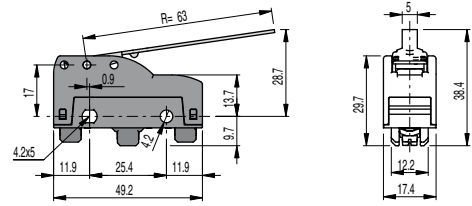

<b>MK V11D30</b>	1NO+1NC	PC 9 mm	FS 0,65 N
		OC 10 mm	FR 0,5 N
		CD 1,1 mm	

Max and min. speed page 7/8 - type 3

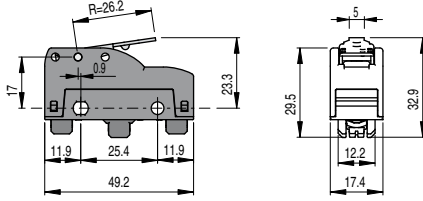

<b>MK V11D31</b>	1NO+1NC	PC 4,54 mm	FS 1,66 N
		OC 3,86 mm	FR 1,32 N
		CD 0,42 mm	

Max and min. speed page 7/8 - type 3

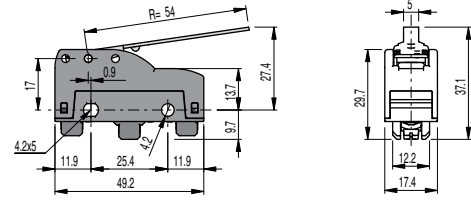

<b>MK V11D32</b>	1NO+1NC	PC 7,7 mm	FS 0,76 N
		OC 8,3 mm	FR 0,58 N
		CD 0,9 mm	

Max and min. speed page 7/8 - type 3

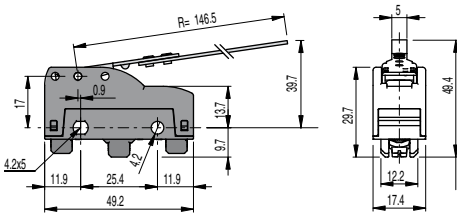

<b>MK V11D35</b>	1NO+1NC	PC 19 mm	FS 0,28 N
		OC 16,7 mm	FR 0,22 N
		CD 2,5 mm	

Max and min. speed page 7/8 - type 3

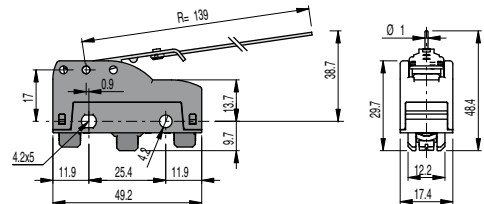

<b>MK V11D37</b>	1NO+1NC	PC 19 mm	FS 0,08 N
		OC 9,5 mm	FR 0,04 N
		CD 2,3 mm	

Max and min. speed page 7/8 - type 3

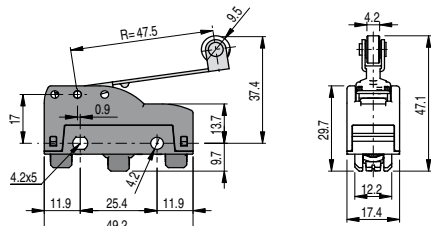

<b>MK V11D40</b>	1NO+1NC	PC 6,7 mm	FS 0,86 N
		OC 7,8 mm	FR 0,66 N
		CD 0,8 mm	

Max and min. speed page 7/8 - type 6

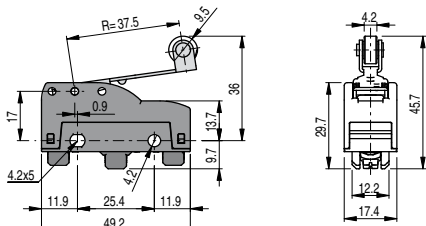

<b>MK V11D42</b>	1NO+1NC	PC 5,3 mm	FS 1,09 N
		OC 5,7 mm	FR 0,84 N
		CD 0,6 mm	

Max and min. speed page 7/8 - type 6

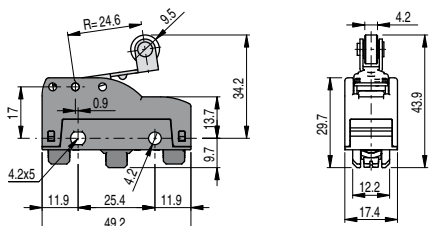

<b>MK V11D45</b>	1NO+1NC	PC 3,5 mm	FS 1,66 N
		OC 4,5 mm	FR 1,28 N
		CD 0,4 mm	

Max and min. speed page 7/8 - type 6

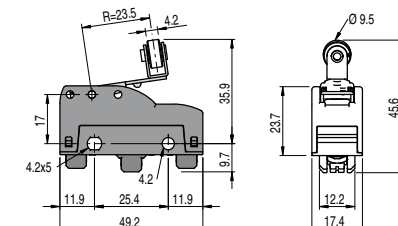

<b>MK V11D46</b>	1NO+1NC	PC 3,5 mm	FS 1,66 N
		OC 4,5 mm	FR 1,28 N
		CD 0,4 mm	

Max and min. speed page 7/8 - type 6

Items with code on the green background are available in stock



It switch →      ← It does not switch

<b>MK V11D47</b>	1NO+1NC	PC 3,5 mm	FS 1,66 N
		OC 4 mm	FR 1,28 N
		CD 0,4 mm	

Max and min. speed page 7/8 - type 6

<b>MK V11D49</b>	1NO+1NC	Hand operated	
------------------	---------	---------------	--

Max and min. speed page 7/8 - type 3

<b>MK V11D53</b>	1NO+1NC	PC 7,7 mm	FS 0,76 N
		OC 8,9 mm	FR 0,58 N
		CD 0,9 mm	

Max and min. speed page 7/8 - type 6

<b>MK V11D59</b>	1NO+1NC	PC 2,5 mm	FS 2,3 N
		OC 4,5 mm	FR 1,77 N
		CD 0,2 mm	

Max and min. speed page 7/8 - type 6

**Microswitches with inverted action** **10 pcs packs**

<b>MK V11R30</b>	1NO+1NC	PC 4,4 mm	FS 0,6 N
		OC 14 mm	FR 0,4 N
		CD 1 mm	

Max and min. speed page 7/8 - type 4

<b>MK V11R31</b>	1NO+1NC	PC 0,7 mm	FS 1,47 N
		OC 6,01 mm	FR 0,72 N
		CD 0,23 mm	

Max and min. speed page 7/8 - type 4

<b>MK V11R32</b>	1NO+1NC	PC 3,7 mm	FS 0,7 N
		OC 11,8 mm	FR 0,5 N
		CD 0,8 mm	

Max and min. speed page 7/8 - type 4

<b>MK V11R35</b>	1NO+1NC	PC 14,3 mm	FS 0,3 N
		OC 25,7 mm	FR 0,2 N
		CD 3,2 mm	

Max and min. speed page 7/8 - type 7

<b>MK V11R40</b>	1NO+1NC	PC 3,4 mm	FS 0,8 N
		OC 10,3 mm	FR 0,5 N
		CD 0,7 mm	

Max and min. speed page 7/8 - type 7

<b>MK V11R42</b>	1NO+1NC	PC 2,7 mm	FS 1,2 N
		OC 7,9 mm	FR 1,7 N
		CD 0,5 mm	

Max and min. speed page 7/8 - type 7

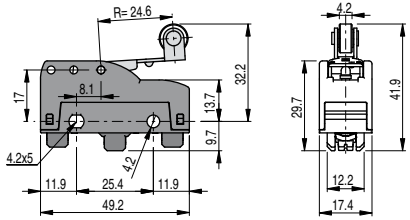

<b>MK V11R45</b>	1NO+1NC	PC 1,5 mm OC 5,5 mm CD 0,3 mm	FS 1,7 N FR 1 N
------------------	---------	-------------------------------------	--------------------

Max and min. speed page 7/8 - type 7

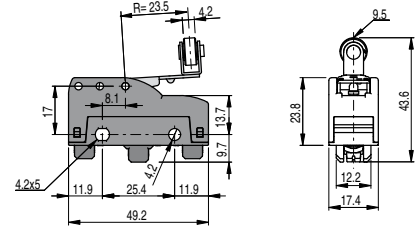

<b>MK V11R46</b>	1NO+1NC	PC 3,5 mm OC 5,4 mm CD 0,2 mm	FS 1,5 N FR 1,45 N
------------------	---------	-------------------------------------	-----------------------

Max and min. speed page 7/8 - type 7

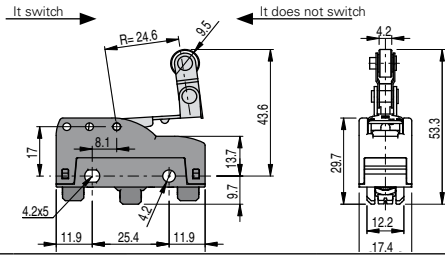

<b>MK V11R47</b>	1NO+1NC	PC 1,7 mm OC 5,3 mm CD 0,3 mm	FS 1,7 N FR 1 N
------------------	---------	-------------------------------------	--------------------

Max and min. speed page 7/8 - type 7

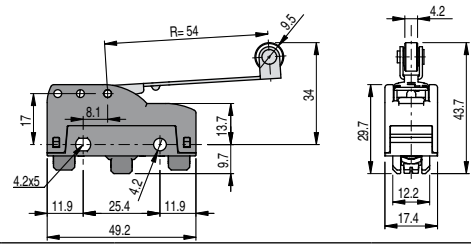

<b>MK V11R53</b>	1NO+1NC	PC 4,3 mm OC 11,6 mm CD 0,8 mm	FS 0,8 N FR 0,4 N
------------------	---------	--------------------------------------	----------------------

Max and min. speed page 7/8 - type 7

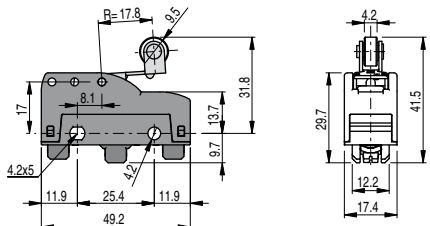

<b>MK V11R59</b>	1NO+1NC	PC 1,5 mm OC 3,9 mm CD 0,3 mm	FS 2,4 N FR 1,3 N
------------------	---------	-------------------------------------	----------------------

Max and min. speed page 7/8 - type 7

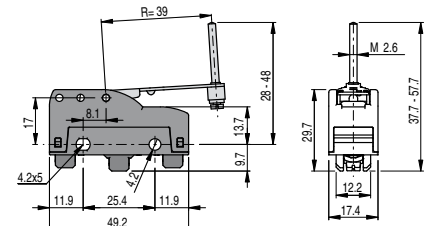

<b>MK V11R60</b>	1NO+1NC	PC 2,7 mm OC 9,2 mm CD 0,5 mm	FS 1,2 N FR 0,6 N
------------------	---------	-------------------------------------	----------------------

Max and min. speed page 7/8 - type 4

**Microswitches with back direct action**

**10 pcs packs**

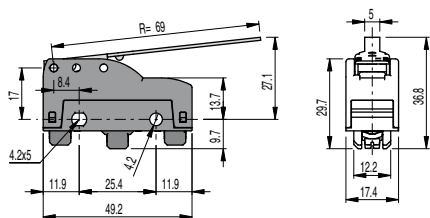

<b>MK V11F30</b>	1NO+1NC	PC 2,7 mm OC 12,9 mm CD 0,35 mm	FS 0,6 N FR 0,5 N
------------------	---------	---------------------------------------	----------------------

Max and min. speed page 7/8 - type 5

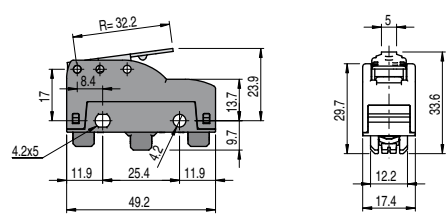

<b>MK V11F31</b>	1NO+1NC	PC 1,63 mm OC 4,64 mm CD 0,17 mm CAP 5,72 mm	FS 1,76 N FR 1,08 N FAP 5,78 N
------------------	---------	---	--------------------------------------

Max and min. speed page 7/8 - type 5

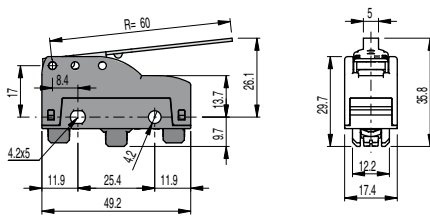

<b>MK V11F32</b>	1NO+1NC	PC 2,5 mm OC 11,5 mm CD 0,3 mm	FS 0,7 N FR 0,6 N
------------------	---------	--------------------------------------	----------------------

Max and min. speed page 7/8 - type 5

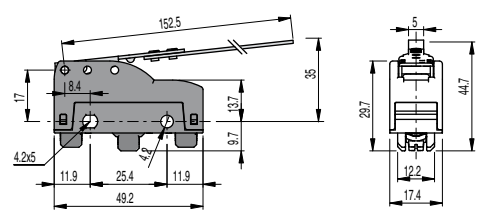

<b>MK V11F35</b>	1NO+1NC	PC 7,5 mm OC 25,9 mm CD 1,3 mm	FS 0,25 N FR 0,2 N
------------------	---------	--------------------------------------	-----------------------

Max and min. speed page 7/8 - type 5

Items with code on the green background are available in stock

<b>MK V11F40</b>	1NO+1NC	PC 2,4 mm	FS 0,85 N
		OC 10,4 mm	FR 0,65 N
		CD 0,25 mm	

Max and min. speed page 7/8 - type 8

<b>MK V11F42</b>	1NO+1NC	PC 1,6 mm	FS 1 N
		OC 8,4 mm	FR 0,7 N
		CD 0,2 mm	FAP 4,9 N
		CAP 9 mm	

Max and min. speed page 7/8 - type 8

<b>MK V11F45</b>	1NO+1NC	PC 1,1 mm	FS 1,3 N
		OC 6,6 mm	FR 0,9 N
		CD 0,1 mm	FAP 6,9 N
		CAP 6,3 mm	

Max and min. speed page 7/8 - type 8

<b>MK V11F46</b>	1NO+1NC	PC 1,1 mm	FS 1,3 N
		OC 6,6 mm	FR 0,9 N
		CD 0,1 mm	FAP 6,9 N
		CAP 6,3 mm	

Max and min. speed page 7/8 - type 8

<b>MK V11F47</b>	1NO+1NC	PC 1,1 mm	FS 1,3 N
		OC 5,6 mm	FR 0,9 N
		CD 0,1 mm	FAP 6,9 N
		CAP 6,3 mm	

Max and min. speed page 7/8 - type 8

<b>MK V11F49</b>	1NO+1NC	PC 1,5 mm	FS 1 N
		OC 7,5 mm	FR 0,7 N
		CD 0,2 mm	FAP 4,8 N
		CAP 9 mm	

Max and min. speed page 7/8 - type 5

<b>MK V11F53</b>	1NO+1NC	PC 2,5 mm	FS 0,7 N
		OC 11,5 mm	FR 0,6 N
		CD 0,3 mm	

Max and min. speed page 7/8 - type 8

<b>MK V11F59</b>	1NO+1NC	PC 0,8 mm	FS 1,7 N
		OC 5,2 mm	FR 1,3 N
		CD 0,08 mm	FAP 8,9 N
		CAP 4,9 mm	

Max and min. speed page 7/8 - type 8

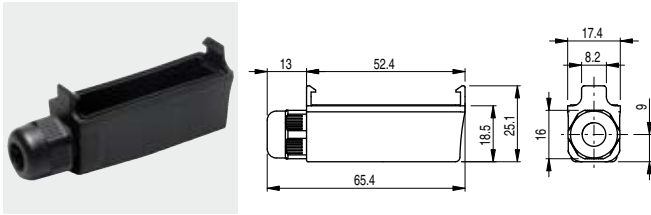
**Protections (terminals covers)**
**10 pcs packs**

Protection terminal cover for screw terminals snap-in assembled and with wire trap cable gland. It allows the installation of more switches side by side.

Article	Description	Protection degree
VF MKCV11	Protection terminal cover without gasket for multipolar cables from Ø 5 to Ø 7,5 mm	IP40
VF MKCV12	Protection terminal cover without gasket for multipolar cables from Ø 4 to Ø 7,5 mm	IP40
VF MKCV13	Protection terminal cover without gasket for multipolar cables from Ø 2 to Ø 5,5 mm	IP40
VF MKCV22	Protection terminal cover with gasket for multipolar cables from Ø 4 to Ø 7,5 mm	IP65
VF MKCV23	Protection terminal cover with gasket for multipolar cables from Ø 2 to Ø 5,5 mm	IP65

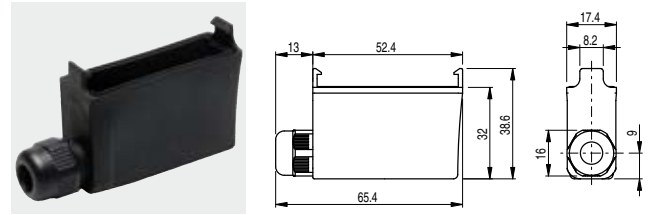

Protection terminal cover for vertical faston terminals snap-in assembled and with wire trap cable gland. It allows the installation of more switches side by side.

Article	Description	Protection degree
VF MKCH11	Protection terminal cover without gasket for multipolar cables from Ø 5 to Ø 7,5 mm	IP40
VF MKCH12	Protection terminal cover without gasket for multipolar cables from Ø 4 to Ø 7,5 mm	IP40
VF MKCH13	Protection terminal cover without gasket for multipolar cables from Ø 2 to Ø 5,5 mm	IP40
VF MKCH22	Protection terminal cover with gasket for multipolar cables from Ø 4 to Ø 7,5 mm	IP65
VF MKCH23	Protection terminal cover with gasket for multipolar cables from Ø 2 to Ø 5,5 mm	IP65

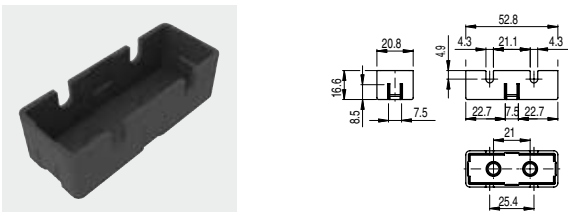

Article	Description	Protection degree
VF C01	Protection terminal cover for screw terminals	IP20

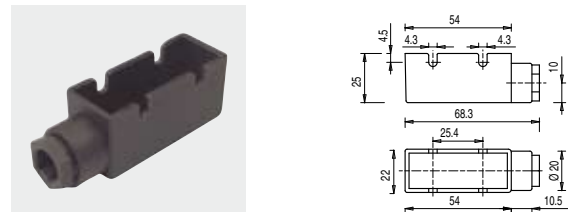

Article	Description	Protection degree
VF C02	Protection terminal cover for screw terminals with cable gland PG9 for multipolar cables from Ø 5 to Ø 7 mm	IP40

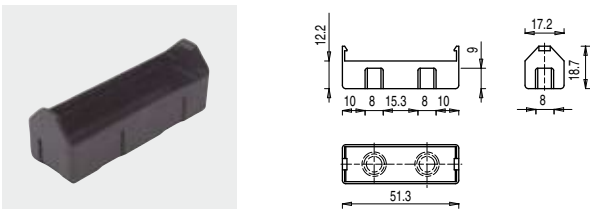

Article	Description	Protection degree
VF C03	Protection terminal cover for screw terminals snap-in assembled. It allows the installation of more switches side by side	IP20

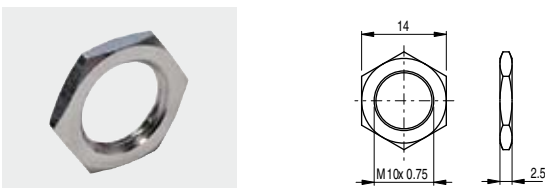
**Accessories**
**10 pcs packs**

Article	Description
AC83	Hexagonal threaded nut M10 x 0,75 for microswitches

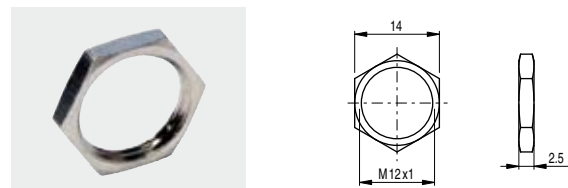

Article	Description
AC72	Hexagonal threaded nut M12 x 1 for microswitches