

Digital Fiber Amplifier

D2RF/D2GF Series

Analog Output Model
D2RF-TAN D2RF-TAP
D2RF-2TAN D2RF-2TAP

Instruction Manual

- Thank you for purchasing DSA-Series. We hope you are fully satisfied with this product and enjoy its performance.
- Carefully read this instruction manual and keep it for future reference.

Carefully read and understand the safety precautions before operation. The important information is provided to protect your health and property. Do not apply any other installing or operating procedure other than that described in this manual.

Safety Precautions

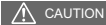

- It is dangerous to wire or attach/remove the connector with the power on. Make sure to turn off the power before operation.
- Make sure to use the product with the protective cover attached and closed.
- Installing in the following places may result in malfunction:
 - A dusty or steamy place
 - A place generating corrosive gas
 - A place directly receiving scattering water or oil.
 - A place suffered from heavy vibration or impact.
- The product is not designed for outdoor use.
- Do not use the sensor in transient state after power on (approx. 100 ms).
- Do not wire with the high voltage cable or the power line. Failure to do this will cause malfunction by induction or damage.
- The sensor performance or digital display values may depend on the individual units or the condition of detected product.
- This product is not an explosion-proof construction. Do not use the product under flammable, explosive gas or liquid environment.
- Do not use the product in water.
- Do not disassemble, repair, or convert the product. Failure to do this may cause failure, fire, or electric shock.
- Operate within the rated range.

This product cannot be used as a safety device to protect human body.

Input/Output Schematic

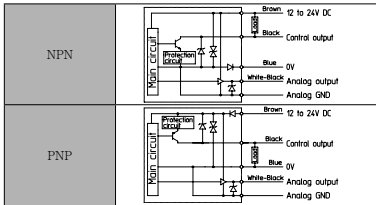

	Standard	D2RF-TA (N/P)
Cable type	IP66	D2RF-2TA (N/P)
Power source, voltage	12-24V DC ±10% (including a ripple)	
Consumption current	45mA or less / 24V (When not using analog output.)	
Response time	60µs/250µs/2ms (Fast/Standard/Long)	
Control output	NPN / PNP Open collector 100mA / 30V or less	
Output method	Light on / Dark on Switching type in the function	
Short-circuit protection	Incorporated	
Light source	Red LED	
Indicator light / Display	Orange (output) / 7 segment 8 digit display	
Sensitivity setting	Teaching / Manual adjustment	
Timer function	OFF, On delay timer, Off delay timer, One-shot timer	
Timer time	1ms-9s	
Analog output	Analog output : 4-20mA	
Operating temperature/humidity	-25 ~ +55°C / 35 ~ 85%RH (No freezing and No condensation)	
Storage temperature/humidity	-40 ~ +70°C / 35 ~ 85%RH (No freezing and No condensation)	
Shock resistance	10 ~ 55Hz Amplitude 1.5mm 2 hours for each direction of X, Y and Z	
Protective category	IP50 / IP66	
Material	PPE : Case , PC / Cover, Case (IP66)	
Weight (Including cordes)	70g	

Each Part

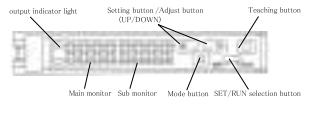

Setting Amplifier

Attaching and Removing to/from DIN rail

Attachment of Amplifier Unit

Hook the claw of the connecting side of fiber cable to the DIN rail. Then press down the hook until it locks.

Removal of Amplifier Unit

Pushing the unit to the direction of ①, hold up the connecting side of fiber cable and remove the unit.

How to connect the fiber cables

- Open fiber lock lever.
- Insert fiber into holes to stop.
- Return fiber lock lever until it stops.

CAUTION

With Coaxial reflection fiber, set single core fiber or white-lined fiber to the emitter. Then set Multi wick fiber to the receiver

How to use Fine fiber

- Turn adapter cap anticlockwise completely, then appropriately insert the fiber. Be locked by turning adapter cap clockwise.
- Cut the excess fiber with fiber cutter.

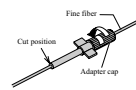

Adjustment

Setting Maximum Sensitivity

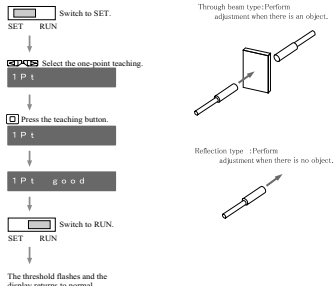

One Point Teaching

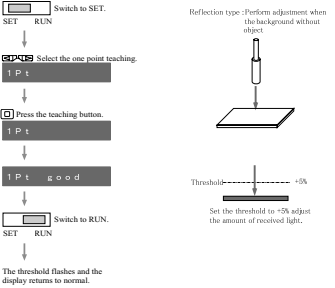

Two Points Teaching

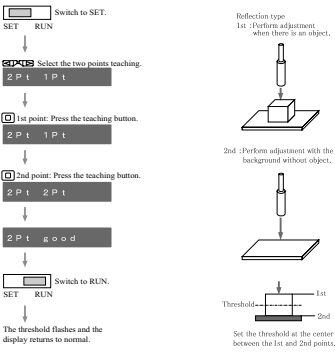

Auto Teaching

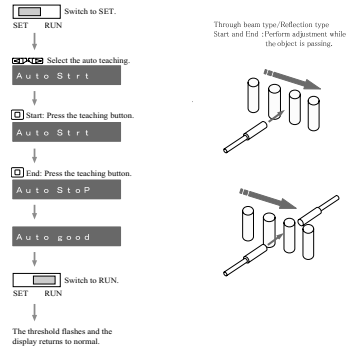

Zone Teaching

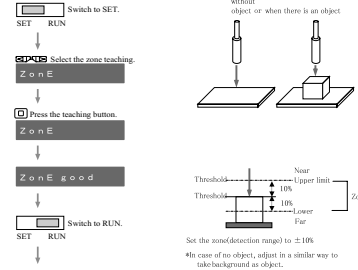

Teaching Transparent Object

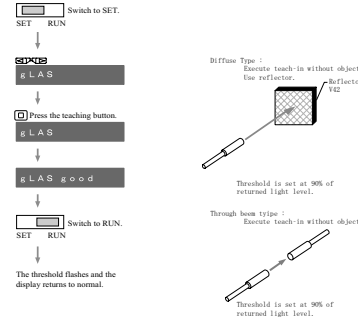

Manual Adjustment

Pressing the UP/DOWN button in the RUN mode flashes the threshold. It indicates that adjustment is possible. Adjust to any value using the UP/DOWN button.

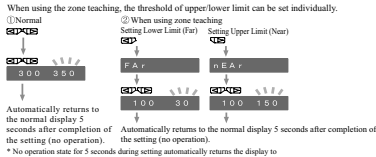

Error Display in Teaching

Error Code	Description
E r r 1	Indicates shortage of light intensity or no difference of light intensity.
E r r 2	Indicates a sampling error in teaching of a moving object.
E r r 3	Indicates a calculation error.
o n t o p l t	Indicates that the teaching is interrupted.

Function Setting

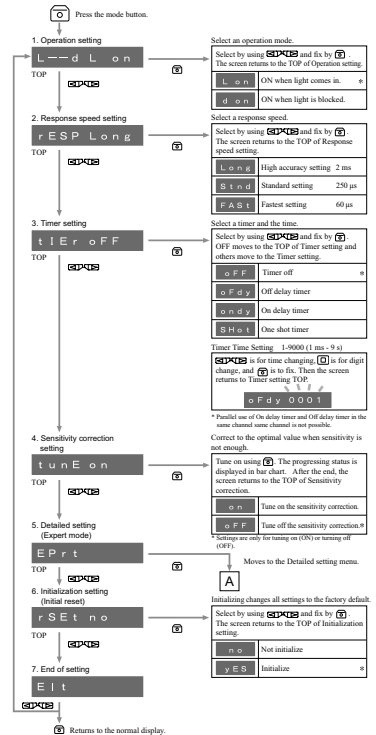

Precautions for Function Setting

- m means factory default setting.
- Invalid settings are not indicated automatically. These are not any troubles and failures.
- Hold down the operation button for approx. 0.3 seconds if not especially specified.
- The sub monitor starts flashing when each setting selection becomes available.

Returning to Normal Display with One Button

Pressing the [] button for 2 seconds or more in setting each function enables to return to the normal display (RUN mode) without using Exit (Exit).

Key Lock

Cancels all the operations. Useful to prevent accidental operation. Hold down the [] buttons for 2 seconds or more simultaneously in the RUN mode. Operate in the same way to cancel as well.

Reset "Peak/Bottom hold"

Peak/Bottom hold can be reset by operating with amplifier itself at the time of analog output.

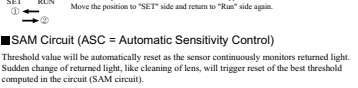

SAM Circuit (ASC = Automatic Sensivity Control)

Threshold value will be automatically reset as the sensor continuously monitors returned light. Sudden change of returned light, like cleaning of lens, will trigger reset of the best threshold computed in the circuit (SAM circuit).

Dimensional drawing

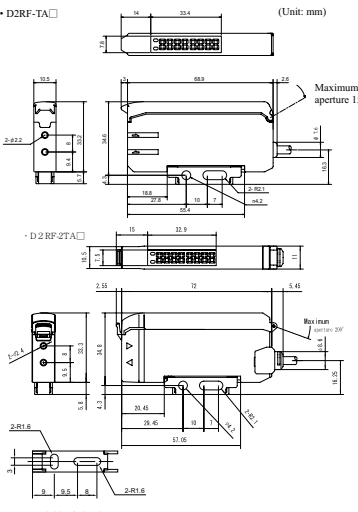

Options

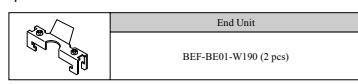

Specifications and equipment are subject to change without any obligations on the part of manufacturer.

Manufactured and sold by:
OPTEX FA CO., LTD.
Head office: Mitsui Seimei Kyoto Yamashina BLDG 6F, 46-1Takehachidononaka-cho, Yamashina-ku, Kyoto 607-8085 Japan
TEL: +81-(0)75-594-8123
FAX: +81-(0)75-594-8124

Digital Fiber Amplifier

D2RF/D2GF Series

D2RF-□□□□ D2GF-□□□□
D2RF-T□□□□ D2GF-T□□□□

Instruction Manual

Thank you for purchasing D2A-Series. We hope you are fully satisfied with this product and enjoy its performance.
Carefully read this instruction manual and keep it for future reference.

Safety Precautions

- It is dangerous to wire or attach/remove the connector with the power on. Make sure to turn off the power before operation.
- Make sure to use the product with the protective cover attached and closed.
- Installing in the following places may result in malfunction:
 - A dusty or steamy place
 - A place generating corrosive gas
 - A place directly receiving scattering water or oil.
 - A place suffered from heavy vibration or impact.
- The product is not designed for outdoor use.
- Do not use the sensor in transient state after power on (approx. 100 ms).
- Do not wire with high voltage cable or the power line. Failure to do this will cause malfunction by induction or damage.
- The sensor performance or digital display values may depend on the individual units or the condition of detected product.
- This product is not an explosion-proof construction. Do not use the product under flammable, explosive gas or liquid environment.
- Do not use the product in water.
- Do not disassemble, repair, or convert the product.
- Failure to do this may cause failure, fire, or electric shock.
- Operate within the rated range.

This product cannot be used as a safety device to protect human body.

Input/Output Schematic

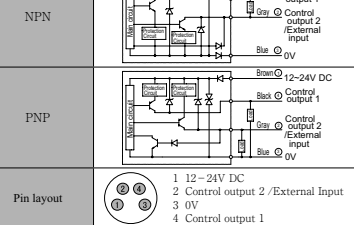

Manual Adjustment

Pressing the UP/DOWN button in the RUN mode flashes the threshold. It indicates that adjustment is possible. Adjust to any value using the UP/DOWN button.
When using the zone teaching, the threshold of upper/lower limit can be set individually.

① Normal
 ② When using zone teaching
 Setting Lower Limit (Far) Setting Upper Limit (Near)

Automatically returns to the normal display 5 seconds after completion of the setting (no operation).
 * No operation state for 5 seconds during setting automatically returns the display to normal.

Error Display in Teaching

An error message is displayed in the event of error during adjustment.
Refer to the table below for readjustment.

Err1	Indicates shortage of light intensity or no difference of light intensity.
Err2	Indicates a sampling error in teaching of a moving object.
Err3	Indicates a calculation error.
no iPL	Indicates that the teaching is interrupted.

Function Setting

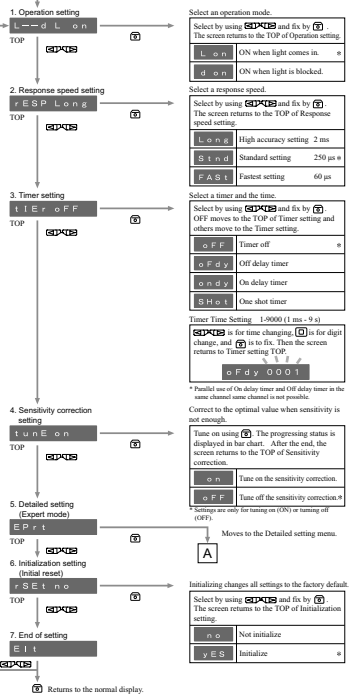

Model	Standard type	Color mark type
Cable type	D2RF-TM (N/P)	D2GF-TM (N/P)
Base unit	D2RF-TS (N/P)	D2GF-TS (N/P)
MS connector type	D2RF-TMC (N/P) 4	D2GF-TMC (N/P) 4
Power source, voltage	12-24V DC -10% (including ripple)	
Consumption current	45mA or less / 24V	
Response time	60μs/250μs/2ms (Fast Standard/Long)	
Control output	NPN / PNP Open collector 100mA / 30V or less (output 1/output 2) Load current : 100mA or less Residual voltage : 1.8V or less	
Short-circuit protection	Incorporated	
Light source	Red LED	Green LED
Indicator light / Display	Output Indicator light Base unit: Orange/output 1/output 2 / 7 segment 8 digit display Handset unit: Orange/output 1 / 7 segment 8 digit display	
Sensitivity setting	Teaching / Manual adjustment	
Timer function	OFF, On delay timer, Off delay timer, One-shot timer	
Timer time	1ms-9s	
Setting input/output	Output setting (Output 2 or Alarm output)	
Operating temperature/humidity	25 - +55°C / 35 - 85%RH (No freezing and No condensation)	
Store temperature/humidity	-40 - +70°C / 35 - 85%RH (No freezing and No condensation)	
Shock resistance	10 - 55Hz Amplitude 1.5mm 2 hours for each direction of X, Y and Z	
Protective category	IP50	
Material	PPE : Case PC / Cover	
Weight	Cable type : 65g (Including codes) MS Connector type : 18g	

*Operating temperature must be after according to the number of connection.
 1.3 machine: -25 to +50°C (Output current within 50mA) / 5.6 machine: -25 to +26°C (Output current within 50mA)

Each Part

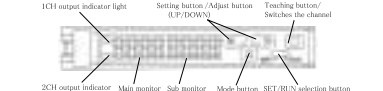

Attaching and Removing to/from DIN rail

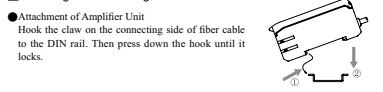

How to connect the fiber cables

- Open fiber lock lever.
 - Insert fiber into holes to stop.
 - Return fiber lock lever until it stops.
- (Approximately 15mm - guided by fiber sign)

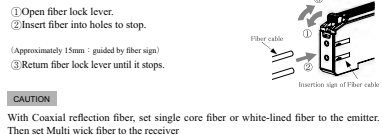

How to use Fine fiber

- Turn adapter cap anticlockwise completely, then appropriately insert the fiber.
- Be locked by turning adapter cap clockwise.
- Cut the excess fiber with fiber cutter.

Expansion of Amplifier Unit

Slide and hook up each amplifier units to DIN rail. And fix it with End units from both sides.

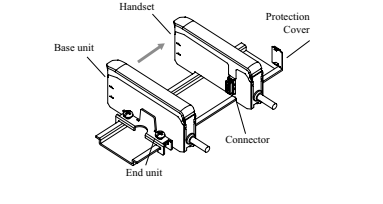

CAUTION

- Make sure to turn off the power before operation.
- Make sure to use the DIN rail and the end unit (BEF-BE01-W190) in expanding the amplifier unit.
- After expansion, make sure to check the operating temperature (See "Specification").
- To avoid short of connecting terminal, protection cover need to be attached to ones which are not in use.
- Do not remove the combined units all together from DIN rail.

Adjustment

Setting Maximum Sensitivity
 Switch to SET. Press the teaching button. The threshold flashes and the display returns to normal.

One Point Teaching
 Switch to SET. Press the teaching button. The threshold flashes and the display returns to normal.

Zone Teaching
 Switch to SET. Press the teaching button. The threshold flashes and the display returns to normal.

Teaching Transparent Object
 Switch to SET. Press the teaching button. The threshold flashes and the display returns to normal.

Change threshold of Alarm output
 With Alarm setting (Alarm output need not be fixed at 5.5 Input/Output setting), threshold (Output timing) can be changed.

SAM Circuit (ASC = Automatic Sensitivity Control)
 Threshold value will be automatically reset as the sensor continuously monitors returned light. Sudden change of returned light, like cleaning of lens, will trigger reset of the best threshold computed in the circuit (SAM circuit).

APC (Auto Power Control)
 Emission LED power is continuously kept at same level compensating damping of LED in the long run of working time. For this function detection level is kept same as preset level.

Precautions for Function Setting
 * means factory default setting.
 * Unavailable settings are not indicated automatically. These are not any troubles and failures.

Returning to Normal Display with One Button
 Pressing the [] button for 2 seconds or more in simultaneously each function enables to return to the normal display (RUN mode) without using Err (Ex) button.

Key Lock
 Cancels all the operations. Useful to prevent accidental operation.

Key Lock
 Hold down the [] buttons for 2 seconds or more simultaneously in the RUN mode. Operate in the same way to cancel as well.

Two Points Teaching

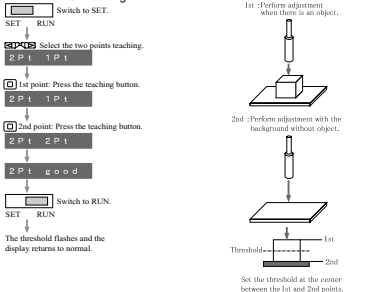

Auto Teaching

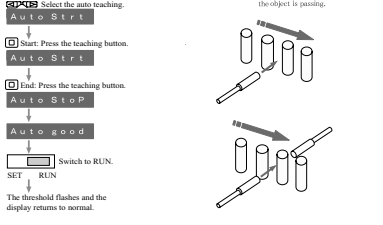

Zone Teaching

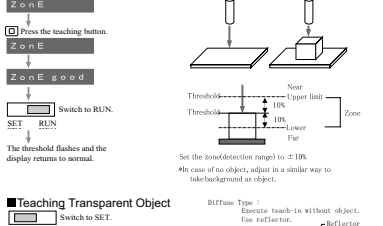

Teaching Transparent Object

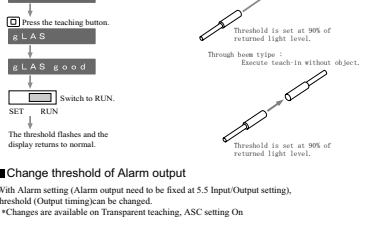

Change threshold of Alarm output

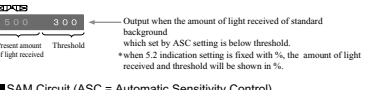

SAM Circuit (ASC = Automatic Sensitivity Control)

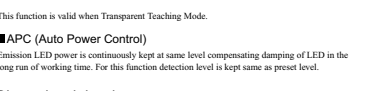

APC (Auto Power Control)

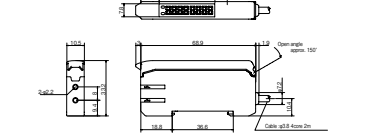

Dimensional drawing

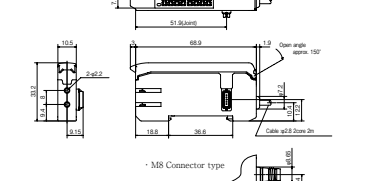

Options

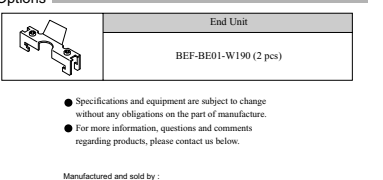

Specifications and equipment are subject to change without any obligations on the part of manufacturer.
 For more information, questions and comments regarding products, please contact us below.

Manufactured and sold by:
OPTEX FA CO., LTD.
 Head office: Mitsui Seimei Kyoto Yamashiro BLDG 6F, 45-1
 Takedanandonocho, Yamashiro-ku, Kyoto
 607-0085 Japan
 TEL: +81-(0)75-594-8123
 FAX: +81-(0)75-594-8124
 Website: <http://www.optex-fa.com>

Digital Fiber Amplifier

D2RF/D2GF Series

D2RF-T □ D2GF-T □
 D2RF-2T □ D2GF-2T □
 D2RF-TC □/4 D2GF-TC □/4
 D2RF-2TC □/3/4 D2GF-2TC □/3/4

Instruction Manual

- Thank you for purchasing DSA Series. We hope you are fully satisfied with this product and enjoy its performance.
- Carefully read this instruction manual and keep it for future reference.

Carefully read and understand the safety precautions before operation. The important information is provided to protect your health and property. Do not apply any other installing or operating procedure other than that described in this manual.

Safety Precautions

- CAUTION**
- It is dangerous to wire or attach/remove the connector with the power on. Make sure to turn off the power before operation.
- Make sure to use the product with the protective cover attached and closed.
- Installing in the following places may result in malfunction:
 - A dusty or steamy place
 - A place generating corrosive gas
 - A place directly receiving scattering water or oil.
 - A place suffered from heavy vibration or impact.
- The product is not designed for outdoor use.
- Do not use the sensor in transient state after power on (approx. 100 ms).
- Do not wire with the high voltage cable or the power line. Failure to do this will cause malfunction by induction or damage.
- The sensor performance or digital display values may depend on the individual units or the condition of detected product.
- This product is not an explosion-proof construction. Do not use the product under flammable, explosive gas or liquid environment.
- Do not use the product in water.
- Do not disassemble, repair, or convert the product. Failure to do this may cause failure, fire, or electric shock.
- Operate within the rated range.

This product cannot be used as a safety device to protect human body.

Input/Output Schematic

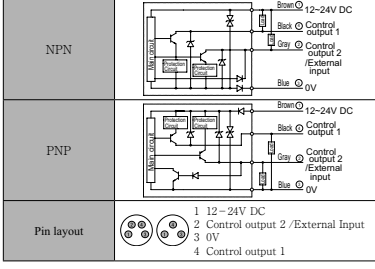

Manual Adjustment

Pressing the UP/DOWN button in the RUN mode flashes the threshold. It indicates that adjustment is possible. Adjust to any value using the UP/DOWN button.

When using the zone teaching, the threshold of upper/lower limit can be set individually.

① Normal ② When using zone teaching
 Setting Lower Limit (Far) Setting Upper Limit (Near)

Automatically returns to the normal display 5 seconds after completion of the setting (no operation).
 * No operation state for 5 seconds during setting automatically returns the display to normal as well.

Error Display in Teaching

An error message is displayed in the event of error during adjustment.

Refer to the table below for readjustment.

Err 1	Indicates shortage of light intensity or no difference of light intensity.
Err 2	Indicates a sampling error in teaching of a moving object.
Err 3	Indicates a calculation error.
Err 4	Indicates that the teaching is interrupted.

Function Setting

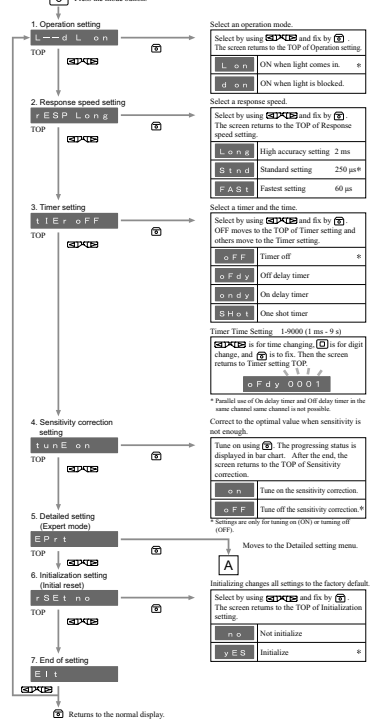

Model	Standard type		Color mark type	
	Standard	D2RF-T (N/P)	D2GF-T (N/P)	D2GF-T (N/P)
Cable type	IP66	D2RF-2T (N/P)	D2GF-2T (N/P)	D2GF-2T (N/P)
M8 connector type	IP66	D2RF-TC (N/P) 4	D2GF-TC (N/P) 4	D2GF-TC (N/P) 4
Power source, voltage	12-24V DC ±10% (including a ripple)			
Consumption current	45mA or less / 24V			
Response time	60µs/250µs/2ms (Fast/Standard/Long)			
Control output	NPN / PNP Open collector 100mA / 30V or less (output 1/output 2) Load current : 100mA or less Residual voltage : 1.8V or less			
Output method	Light on / Dark on Switching type in the function			
Short-circuit protection	Incorporated			
Light source	Red LED		Green LED	
Indicator light / Display	Output Indicator light - Orange (output 1/output 2) / 7 segment 8 digit display			
Sensitivity setting	Teaching / Manual adjustment			
Timer function	OFF, On delay timer, Off delay timer, One-shot timer			
Timer time	1ms-9s			
Setting input/output	External input setting (Teaching/counter reset)			
Operating temperature/humidity	-25 ~ +55°C / 35 ~ 85%RH (No freezing and No condensation)			
Storage temperature/humidity	-40 ~ +70°C / 35 ~ 85%RH (No freezing and No condensation)			
Shock resistance	10 ~ 55Hz Amplitude 1.5mm 2 hours for each direction of X, Y and Z			
Protective category	IP50 / IP66			
Material	PPE : Case, PC : Cover, Case (IP66)			
Weight (Including cord)	M8 Connector type : 18g, 23g (IP66)			

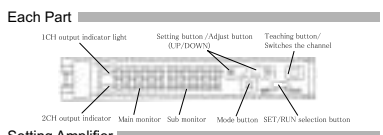

Setting Amplifier

Attaching and Removing to/from DIN rail

① Attachment of Amplifier Unit
 Hook the claw of the connecting side of fiber cable to the DIN rail. Then press down the hook until it locks.

② Removal of Amplifier Unit
 Pushing the unit to the direction of ①, hold up the connecting side of fiber cable and remove the unit.

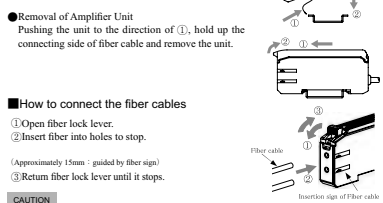

With Coaxial reflection fiber, set single core fiber or white-lined fiber to the emitter. Then set Multi wave fiber to the receiver.

How to use Fine fiber

- Turn adapter cap anticlockwise completely, then appropriately insert the fiber. Be locked by turning adapter cap clockwise.
- Cut the excess fiber with fiber cutter.

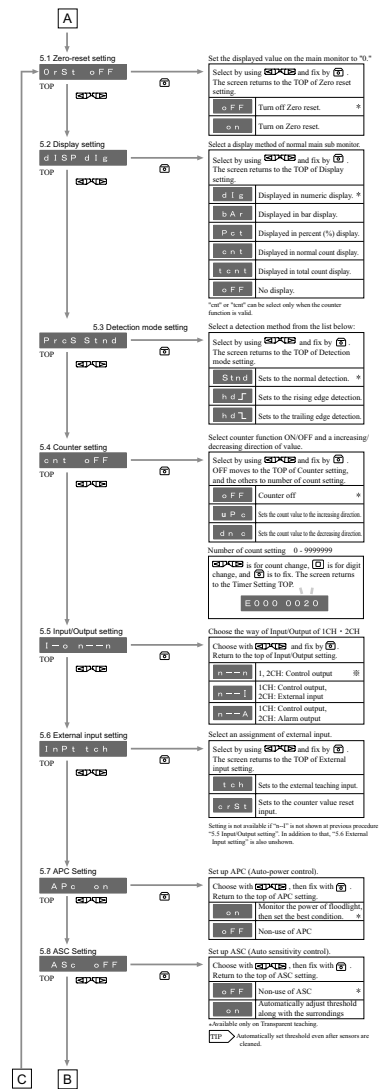

Adjustment

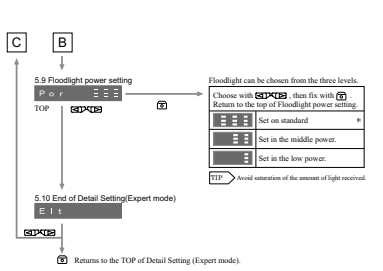
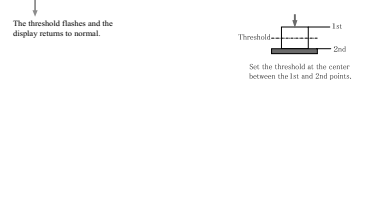
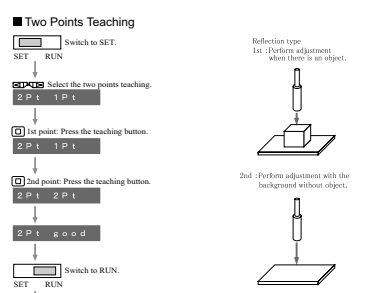
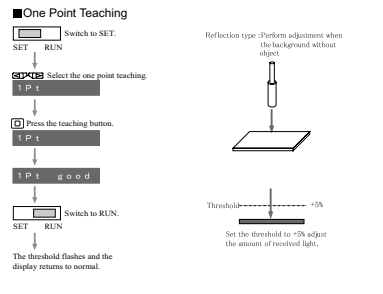
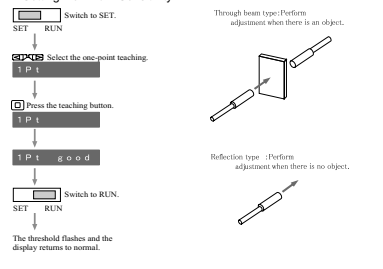

Precautions for Function Setting

- means factory default setting.
- Unavailable settings are not indicated automatically.
- These are not any troubles and failures.
- Hold down the operation button for approx. 0.3 seconds if not especially specified.
- The sub monitor starts flashing when each setting selection becomes available.
- The monitor in use of the counter function displays "U" when the up-counter is selected, and displays "d" when the down-counter is selected.

Switching Channel

Press [CH 2] on Run mode, target channel blinks and switch to it.

Returning to Normal Display with One Button

Pressing the [E] button for 2 seconds or more in setting each function enables to return to the normal display (RUN mode) without using [E] (Exit).
 * Invalid while setting the timer time, number of count, or span limit.

Key Lock

Cancel all the operations. Useful to prevent accidental operation.

Change threshold of Alarm output

With Alarm Setting (Alarm output need to be fixed at 5.5 Input/Output setting), threshold (Output timing) can be changed.
 *Changes are available on Transparent teaching. ASC setting On

Options

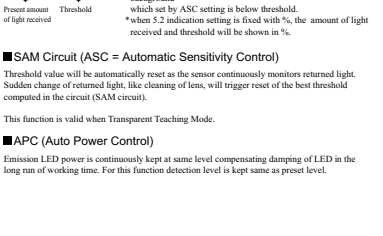

Auto Teaching

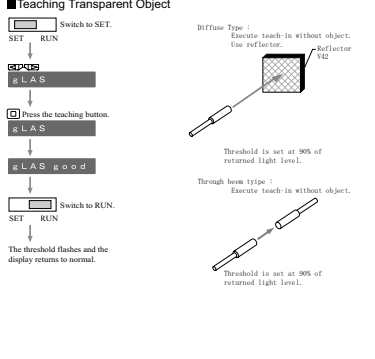
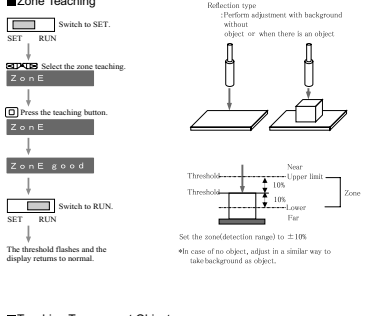
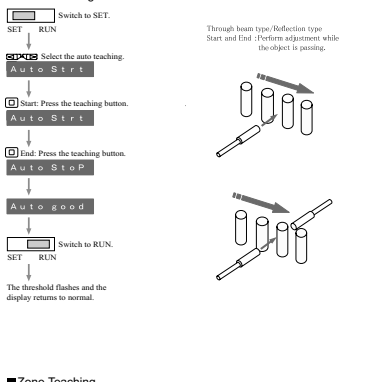

Dimensional drawing

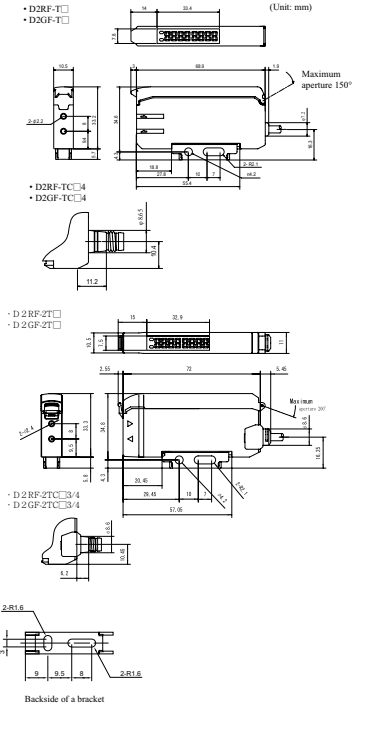

Options

End Unit
 BEF-BE01-W190 (2 pcs)

- Specifications and equipment are subject to change without any obligations on the part of manufacturer.
- For more information, questions and comments regarding products, please contact us below.

Manufactured and sold by:
OPTEX FA CO. LTD.
 Head office: Misui Seimei Kyoto Yamashina BLDG 6F, 46-1
 Takehana-umori-cho, Yamashina-ku, Kyoto
 607-8085 Japan
 TEL: +81-(0)75-594-8123
 FAX: +81-(0)75-594-8124

Website: <http://www.optex-fa.com>