



**■ Features**

- Universal AC input / Full range
- Class II power unit, no FG
- Built-in active PFC function
- High efficiency up to 90.5%
- No load power consumption <0.15W
- Energy efficiency Level VI
- Comply with EISA 2007/DoE,NRCan
- Fully isolated plastic case
- Fanless design, cooling by free air convection
- Protections: Short circuit / Over current / Over voltage / Over temperature
- UL LISTED, suitable for dry and damp locations
- 5 years warranty

**■ Applications**

- Indoor LED lighting
- LED decorative lighting
- LED office lighting
- General electronic products in dusty or humid environment

**■ Description**

OWA-120U is one 120W single-output external LED power supply series. Pairing the North American type of AC plug and the prevailing DC connectors, OWA-120U, working like an adaptor, simplifies the connection with LED lighting fixtures without extra wiring efforts. The entire series is certified with the “UL LISTED” for dry and damp locations.

As a class II (no FG) design, the enclosure of OWA-120U is a 94V-0 flame retardant plastic case. The interior is fully potted with silicone that enhances the heat dissipation. With the working efficiency up to 90.5%, OWA-120U is cooled by free air convection; the working temperature ranges from -40°C to +70°C.

**■ Model Encoding**

**OWA - 120U - 12**

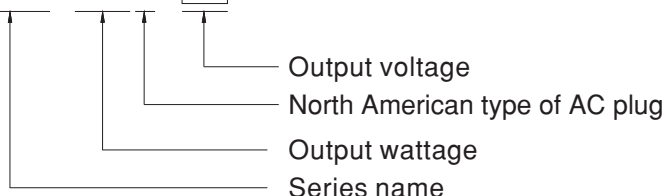



**SPECIFICATION**

MODEL		OWA-120U-12	OWA-120U-15	OWA-120U-20	OWA-120U-24	OWA-120U-30	OWA-120U-36	OWA-120U-42	OWA-120U-48	OWA-120U-54	
OUTPUT	DC VOLTAGE	12V	15V	20V	24V	30V	36V	42V	48V	54V	
	CONSTANT CURRENT REGION	7.2 ~ 12V	9 ~ 15V	12 ~ 20V	14.4 ~ 24V	18 ~ 30V	21.6 ~ 36V	25.2 ~ 42V	28.8 ~ 48V	32.4 ~ 54V	
	RATED CURRENT	10A	8A	6A	5A	4A	3.4A	2.9A	2.5A	2.3A	
	RATED POWER	120W	120W	120W	120W	120W	122.4W	121.8W	120W	124.2W	
	RIPPLE & NOISE (max.) Note.2	150mVp-p	150mVp-p	150mVp-p	150mVp-p	200mVp-p	200mVp-p	250mVp-p	250mVp-p	350mVp-p	
	VOLTAGE TOLERANCE Note.3	±4.0%	±4.0%	±4.0%	±4.0%	±3.0%	±2.0%	±1.0%	±1.0%	±1.0%	
	LINE REGULATION	±0.5%	±0.5%	±0.5%	±0.5%	±0.5%	±0.5%	±0.5%	±0.5%	±0.5%	
	LOAD REGULATION	±2.0%	±1.5%	±1.0%	±0.5%	±0.5%	±0.5%	±0.5%	±0.5%	±0.5%	
	SETUP, RISE TIME Note.4	500ms, 80ms at 95% load 230VAC / 115VAC									
HOLD UP TIME (Typ.)	16ms at full load 230VAC / 115VAC										
INPUT	VOLTAGE RANGE	90 ~ 264VAC		127 ~ 370VDC							
	FREQUENCY RANGE	47 ~ 63Hz									
	POWER FACTOR (Typ.)	PF>0.97/115VAC, PF>0.96/230VAC at full load									
	TOTAL HARMONIC DISTORTION	THD< 20% when output loading ≥60% at 115VAC/230VAC									
	EFFICIENCY (Typ.)	115VAC	87%	88%	89%	89.5%	89%	89%	89.5%	89.5%	89.5%
		230VAC	87.5%	89%	90%	90.5%	90%	90%	90.5%	90.5%	90.5%
	AC CURRENT (Typ.)	1.3A / 115VAC		0.65A / 230VAC							
	INRUSH CURRENT (Typ.)	COLD START 30A(twidth=520µs measured at 50% Ipeak) at 115VAC COLD START 60A(twidth=520µs measured at 50% Ipeak) at 230VAC									
MAX. NO. of PSUs on 16A CIRCUIT BREAKER	4 units (circuit breaker of type B) / 6 units (circuit breaker of type C) at 230VAC										
LEAKAGE CURRENT	<0.125mA / 120VAC		<0.25mA / 240VAC								
PROTECTION	OVER CURRENT	95 ~ 108% Protection type : Constant current limiting, recovers automatically after fault condition is removed									
	SHORT CIRCUIT	Hiccup mode, recovers automatically after fault condition is removed									
	OVER VOLTAGE	15 ~ 17V	17.5 ~ 21V	23 ~ 27V	28 ~ 34V	34 ~ 40V	41 ~ 46V	46 ~ 54V	54 ~ 60V	59 ~ 66V	
		Protection type : Shut down o/p voltage, re-power on to recover									
OVER TEMPERATURE	Shut down o/p voltage, re-power on to recover										
ENVIRONMENT	WORKING TEMP.	-40 ~ +70°C (Refer to "Derating Curve")									
	WORKING HUMIDITY	20 ~ 95% RH non-condensing									
	STORAGE TEMP., HUMIDITY	-40 ~ +80°C, 10 ~ 95% RH									
	TEMP. COEFFICIENT	±0.03%/°C (0 ~ 50°C)									
	VIBRATION	10 ~ 500Hz, 5G 12min./1cycle, period for 72min. each along X, Y, Z axes									
SAFETY & EMC	SAFETY STANDARDS	UL8750 listed, CSA C22.2 No. 250.13-12; IP67(for power body) approved									
	WITHSTAND VOLTAGE	I/P-O/P:3.75KVAC									
	ISOLATION RESISTANCE	I/P-O/P:100M Ohms / 500VDC / 25°C / 70% RH									
OTHERS	EMC EMISSION	Compliance to FCC Part15									
	MTBF	294.3K hrs min. MIL-HDBK-217F (25°C)									
	DIMENSION	191*63*37.5mm									
NOTE	PACKING	1.15Kg; 12pcs/14.8Kg/0.89CUFT									
	<p>1. All parameters NOT specially mentioned are measured at 230VAC input, rated load and 25°C of ambient temperature.</p> <p>2. Ripple &amp; noise are measured at 20MHz of bandwidth by using a 12" twisted pair-wire terminated with a 0.1uf &amp; 47uf parallel capacitor.</p> <p>3. Tolerance : includes set up tolerance, line regulation and load regulation.</p> <p>4. Length of set up time is measured at cold first start. Turning ON/OFF the power supply may lead to increase of the set up time.</p>										

### Block Diagram

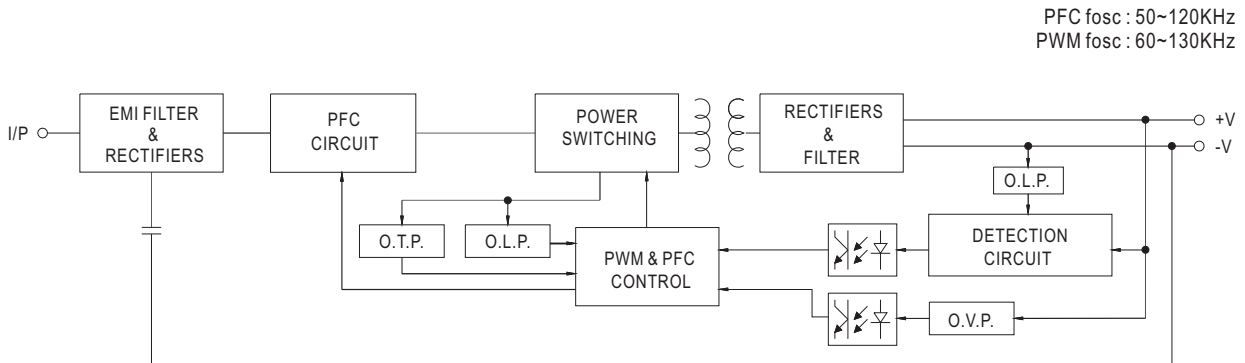

### Derating Curve

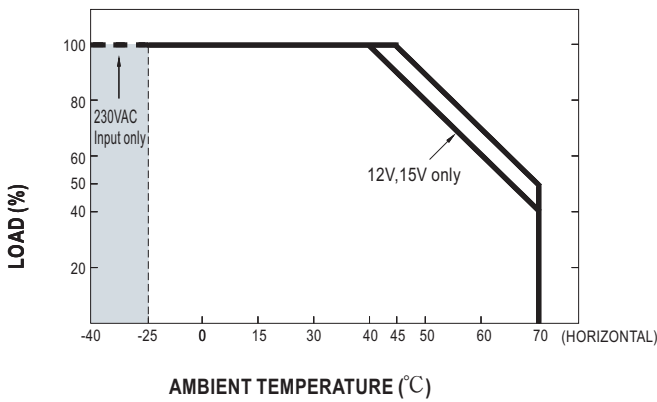

### Static Characteristics

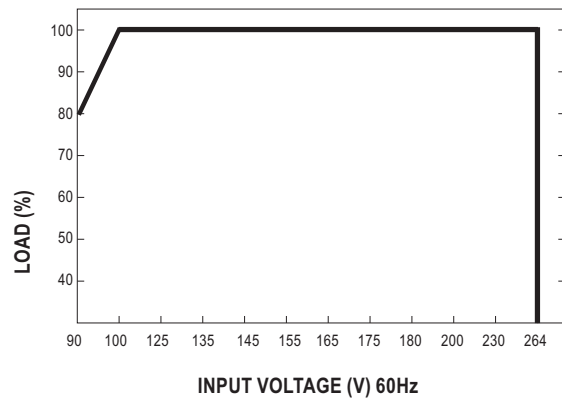

### Power Factor Characteristic

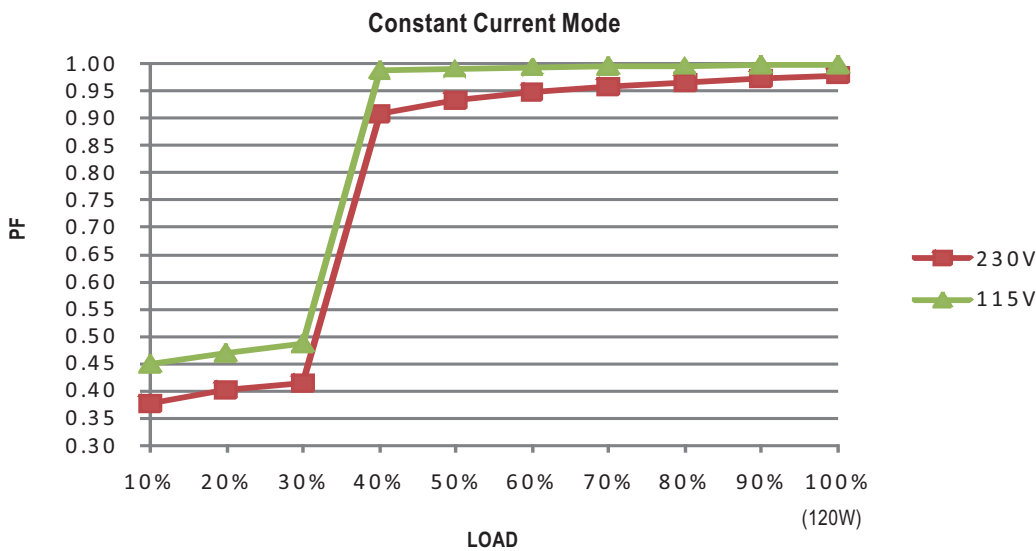

**EFFICIENCY vs LOAD (48V Model)**

OWA-120U series possess superior working efficiency that up to 90.5% can be reached in field applications.

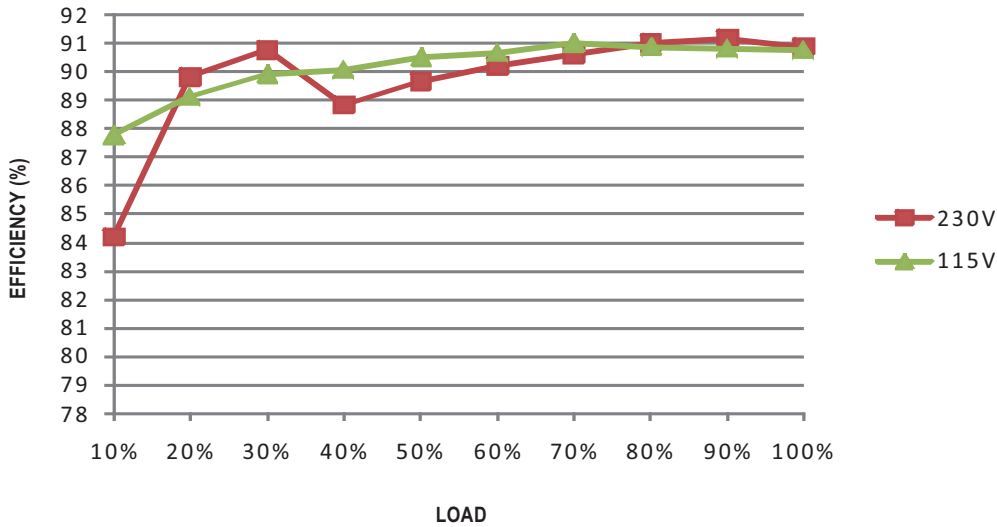

**DRIVING METHODS OF LED MODULE**

There are two major kinds of LED drive method, "direct drive" and "with LED driver".

A typical LED power supply may either work in "constant voltage mode (CV)" or "constant current mode (CC)" to drive the LEDs.

Mean Well's LED power supply with CV+ CC characteristic can be operated at both CV mode (with LED driver, at area (A) and CC mode (direct drive, at area (B)).

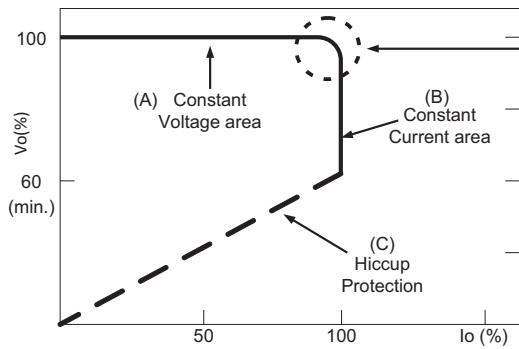

Typical LED power supply I-V curve

In the constant current region, the highest voltage at the output of the driver depends on the configuration of the end systems.

Should there be any compatibility issues, please contact MEAN WELL.

■ Mechanical Specification

Case No. PWM-120

Unit:mm

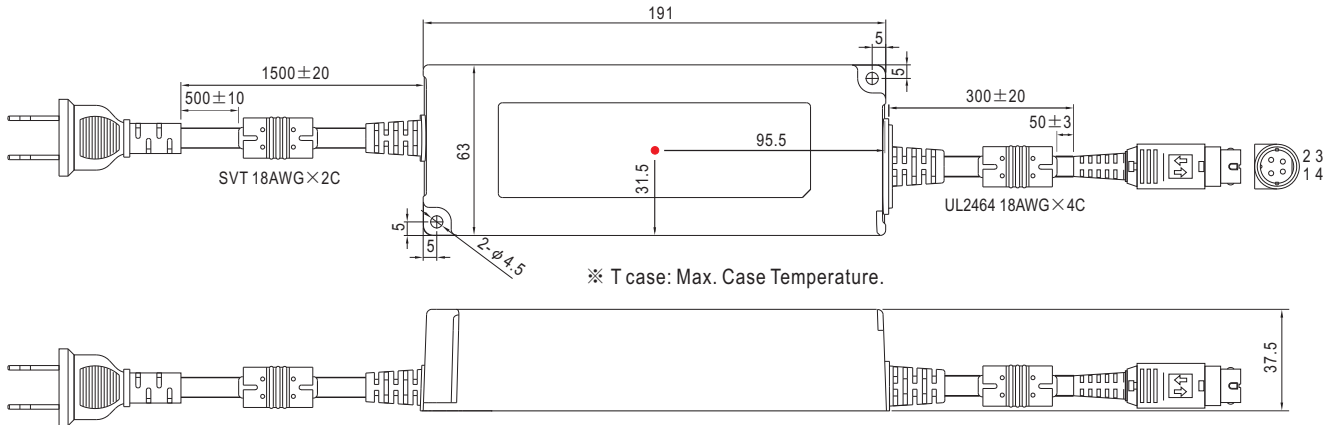

■ Input Plug Type

All models : NEMA 1-15p male plug

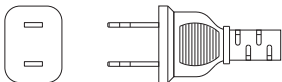

■ Output Plug Assignment

All models : power DIN 4 pins with lock type, KYCON KPPX-4P, or equivalent

	PIN NO.	OUTPUT
	1,4	+V
	2,3	-V

■ Recommend Mounting Direction

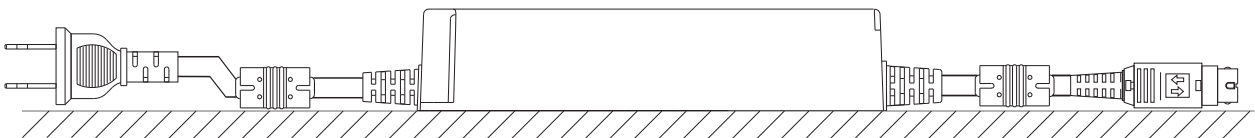

■ Installation Manual

Please refer to : <http://www.meanwell.com/search/OWA-120U/OWA-U-E.pdf>