



Barcode scanner BCL 90

Technical Description



All rights reserved, especially the right of reproduction, distribution and translation. This document may not be duplicated or reproduced in any form (print, photocopy, microfilm or data recording) without the written permission of Leuze electronic GmbH + Co.

It is subject to changes due to technical progress

1	General Information	6
1.1	Explanation of Symbols	6
1.2	Important Terms	6
1.3	Declaration of Conformity	12
2	Safety Notices	13
2.1	Safety Standards	13
2.2	Intended Use	13
2.3	Working Safely	13
2.4	Organisational Measures	15
3	Device Description	17
3.1	The Function of the Device	17
3.1.1	Autofocus Function	18
3.1.2	Event-driven Focus Position Switching	19
3.1.3	Variants of the Scanning Process	20
3.1.4	Other Components	20
3.1.5	Networking	22
3.2	Device Structure	24
3.2.1	Scope of Delivery	24
3.2.2	Device Models	24
3.2.3	System Requirements	25
3.2.4	View of the Device	26
4	Technical Data	27
4.1	Technical Data	27
4.1.1	Data Sheet BCL 90 CAT M 100 / BCL 90 CAT N 100 / BCL 90 CAT F 100	27
4.1.2	Data Sheet BCL 90 CAT OM 100, BCL 90 CAT ON 100, BCL 90 CAT OF 100	29
4.1.3	Data Sheet BCL 90 CAT M 100H, BCL 90 CAT N 100H, BCL 90 CAT F 100H	29
4.1.4	Data Sheet BCL 90 CAT OM 100H, BCL 90 CAT ON 100H, BCL 90 CAT OF 100H	30
4.2	Dimensioned Drawings	30
4.2.1	Line Scanner (Standard Device) with/without Heater	30
4.2.2	Line Scanner with Oscillating Mirror (with/ without Heater)	31
4.3	Optical Data (Specification Diagrams)	32
4.3.1	Reading Conditions for All Diagrams	32
4.3.2	Overview of Diagrams	32
4.3.3	Medium Density: Reading Performance Data of Line Scanner	34
4.3.4	Medium Density: Reading Performance Data of Line Scanner with Oscillating Mirror	40
4.3.5	High Density: Reading Performance Data of Line Scanner	47
4.3.6	High-Density: Reading Performance Data of Line Scanner with Oscillating Mirror	52
4.3.7	Low Density: Reading Performance Data of Line Scanner	58
4.3.8	Low Density: Reading Performance Data of Line Scanner with Oscillating Mirror	62

5	Accessories (Order Codes)	65
5.1	Device and Connection Accessories	65
5.1.1	External Parameter Memory	65
5.1.2	Cables, External Parameter Memories and Plug Covers.....	66
5.2	Mounting Accessories.....	67
5.2.1	Dimensions	68
6	Mounting	69
6.1	Overview of the Mounting Steps	69
6.2	Preparing the Mounting.....	69
6.2.1	Have Ready the Components to be Mounted	69
6.2.2	Have Ready Accessories	69
6.2.3	Lay Aside Auxiliary Materials	69
6.2.4	Exchanging the Laser Warning Sign.....	70
6.2.5	Selecting the Mounting Site	70
6.2.6	Fastening Accessories	70
6.2.7	Distance between BCL and Bar Code	72
6.2.8	Counting Direction of the Code Position CP and Code Angle CW.....	74
6.3	Mounting and Adjusting the Device	75
6.3.1	Mounting the BCL	75
6.4	Mounting External Components.....	75
6.4.1	Mounting Modular Connector Unit MA 90	75
6.4.2	Mounting the External Reading Cycle Sensor.....	76
6.4.3	Mounting Sensors for Object Distance Detection.....	76
7	Electrical Connection	78
7.1	Overview of the Installation Steps.....	78
7.2	Electrical Connections and Cables	78
7.2.1	Core Cross-Sections	78
7.2.2	Pre-assembled Cables (Overview).....	79
7.2.3	Connections/Cables for the Modular Connector Unit MA 90.....	80
7.3	Pin Assignment of the Connections	81
7.3.1	Connections of the BCL	81
7.3.2	Ext. Parameter Memory KB090-3000P No. 500 35 322 (Optional) Plug Cover KB090-3000H No. 500 35 324 (Optional).....	82
7.4	Preparing the Electrical Installation.....	83
7.4.1	Conditions for Using the Host Interface.....	83
7.4.2	Supply Voltage	83
7.4.3	External Power Supply Unit/Wiring without Connector Unit.....	84
7.5	Electrical Installation	88
7.5.1	Overview of the Connection Steps	88
7.5.2	Supplementary Devices	88
7.5.3	Connect supply voltage	88
7.5.4	Connect the BCL 90 host interface	89
7.5.5	Connect the PC.....	90
7.5.6	Connect the Switched Inputs	90
7.5.7	Connect Switched Outputs "SWO 1 ... SWO 4"	94

8	Operation	96
8.1	Overview of the Commissioning Steps	96
8.2	Base Setting.....	96
8.2.1	Base Setting of the Line Scanner BCL 90 (All Models)	96
8.2.2	Base Setting of the Line Scanner BCL 90 with Oscillating Mirror (All Models).....	97
8.3	Display and Operating Elements	98
8.3.1	Operating Elements	98
8.3.2	Function of the LED Indicators	98
8.4	Quick Start	102
8.4.1	Commission the BCL on Factory Default Setting	102
8.5	Configuration (Parameterization)	103
8.5.1	Configure the BCL with User Interface of BCL-Config.....	103
8.6	Oscillating-Mirror Functions	104
8.7	Operating Modes and Output of the Read Result	106
8.7.1	Read Operation (Standard Operating Mode).....	107
8.7.2	Percentage Evaluation.....	108
8.7.3	Calibrating help.....	109
8.7.4	Background Teach-in.....	109
8.7.5	Self Test.....	109
9	Configuration	110
9.1	Calculating of Parameter Values for Setting the BCL	110
9.1.1	Calculating the Number of Scans (for Standard Decoder)	110
9.1.2	Calculating the Starting Position and Deflection Speed for the Forward and Return Phase of the One-Shot	113
9.1.3	Calculating Required Distances between Bar Codes for Reading Several Bar Codes per Object	114
9.2	Overview of Commands and Parameters	115
9.2.1	General 'Online' Commands.....	115
9.2.2	'Online' Command for System Control.....	116
9.3	Installation of the "BCL-Config" software	117
10	Maintenance	118
10.1	Servicing during Operation	118
10.2	Maintenance	119
10.3	Repairs, Servicing.....	119

1 General Information

1.1 Explanation of Symbols

The symbols used in this operating manual are explained below.



Attention!

This symbol appears before text passages that have to be observed by all means. Failure to heed this information may lead to injuries to personnel or damage to the equipment.



Attention laser radiation!

This symbol warns of possible danger due to laser radiation detrimental to health.



Notice!

This symbol indicates text passages containing important information.

1.2 Important Terms

Aspect ratio

The ratio of code height (bar length) to code length (number of characters). The CRT decoder is designed to read even bar codes with extremely small code heights

Autofocus function

The capability of the BCL to detect by itself the distance of the objects in the read process without using external sensors and automatically adapt the focus position to the reading level of the bar code.

BCL-Config

PC program, running under Windows[®]9x/ME or WindowsNT[®]/2000. Used for off-line parameterization (adaptation to the onsite read condition) and online menu-driven operation of the BCL. The *parameter set* to be processed is exchanged with the BCL through *upload* and *download*.

Capture range

A zone set up by the BCL through increment management and comparison of the code position around a moving bar code. This makes it possible, among other purposes, to separate bar codes with identical contents and of the same code types.

Code angle (CW value)

Current deflection width of the scan line (oscillating mirror) across the scan direction when detecting a bar code. The code angle is determined by the BCL for each scan. It is used to define a capture range, for example, to separate bar codes with identical data contents and of the same code types from each other within one area.

Code geometry

Bar code length and height.

Code position (CP value)

The position of the first dark bar of a detected bar code along the *scan line*. It is identified by the BCL in each scan and, for example, used to separate bar codes with identical data contents. For *decoding*, the active evaluation range within the scan line can be defined specifically for an application by pre-setting the minimum and maximum CP values.

Configuration file

File in the PC program BCL-Config in which a complete *parameter set* of the BCL is stored for archiving. The file can be printed in tabular form.

CRT decoder

Purpose-designed *decoder* for reading bar codes with extremely small code heights as well as low-quality or smudged print.

Data output string

Structured data telegram of the *read result* that the BCL outputs in the *host interface*. The structure is flexible and adaptable within a wide range to the requirements of the further processing of data. In contrast, the data output format of the *service interface* is unchangeable.

Decoder, decoding

Code type-dependent evaluation routine for the reconstruction of the read bar code in electronic form so that its data content can be decoded.

Deflection angle

Angle which the *scan line* covers at both sides each of the centre position CW=50 (equivalent to 0°) when deflected by the oscillating mirror. Also called oscillation angle.

Deflection width

Deflection of the scan line by way of the *oscillating mirror* across the scanning direction to both sides of the centre position CW=50 (equivalent to light exit under 105°). Also called oscillation amplitude. While the deflection width is set at maximum in the "oscillation at predefined amplitude" mode, in the "oscillation at variable amplitude" mode, it is adjusted for each distance configuration through the "Oscillating Mirror" Tab in the user interface of BCL-Config.

Distance configuration

Data set in the BCL to establish a *focus position* of the laser beam for event-driven *focus position switching*. The focus position as well as the minimum and maximum *code positions* are to be entered in the "Read Configuration" Tab of the user interface in BCL-Config. For the line scanner with oscillating mirror, the *oscillation amplitude* (deflection width) also have to be entered. The depths of field for the individual focus positions can be obtained from the specification diagram in relation to the resolution.

Distance detection

Device detecting in graduation distances from objects carrying the bar codes. One example is the downward reading of a series of photoelectric sensors arranged in a vertical row beside a transportation line. The ranges for *focus position switching* are defined through combinations of the switched inputs SE 2 to SE 6 and the cross-reference list for *distance configurations*. Only required when the *autofocus function* is not applied.

Distance profile

When using the *autofocus function* with subtraction of background difference, the background without object is to be taught in the BCL before a read can take place. In a special measurement mode, the BCL generates a profile of the distance variation in its field of view along the scan line. This profile enables the BCL to detect objects in the reading field and adjust the required focus position on the plane of the bar code on the object.

Download

The process of transmitting the *parameter set* that was modified off-line in the user interface of *BCL-Config* from the PC to the BCL. BCL-Config always transmits a copy to the operating memory (RAM) of the BCL.

External parameter memory

Optional accessory integrated in a plug cover. This design renders an easy exchange of device possible by locating the parameter set of the BCL as copy in an external memory (EEPROM). The replacement device accesses the memory directly and does not need to be configured manually.

Focus position switching

The capability of the BCL to shift the focus of the laser beam within a wide range on the read level. Focus position switching is event-driven (e.g. through distance detection) or occurs dynamically in the *autofocus function*.

Focus position

Distance of the focal point of the emitted laser beam from the reading window. Adjustable via the optical system in the BCL. Defines a distance-dependent depth of field range (DOF) in which the bar code can be detected.

Function interfaces

Switched inputs and outputs of the BCL.

Good Read

In the concluded *reading cycle*, the BCL either detected the bar code or the required number of bar codes given by the evaluation conditions set in the parameters.

Header

Data block in the read result of the *host interface*. It serves as header in the *data output string* for subsequent data contents of the bar codes. It contains, depending on configuration, read diagnosis data and/or constants (e.g. alphabets). In its basic setting, it is empty.

Host interface

Main data interface of the BCL with configurable data output format. The host interface serves, among others, to output the *read result* in telegram form to the host/PLC. It is used to integrate the BCL in the Leuze network or build up a stand-alone system. It offers various transmission protocols.

Increment management

In the BCL for certain applications, it serves to unambiguously distinguish between bar codes which have identical contents and move during the read process.

Leuze multiNet plus

Special, powerful combination of a maximum of 32 BCLs with high data transmission rates via the RS 485 interface. Co-ordination (polling) and connection of the BCLs to the host by means of the network master MA 31.

Line scanner with oscillating mirror

Line scanner that additionally deflects its laser beam across the scanning direction to the two sides of a centre position by means of an oscillating mirror. In this way, the BCL can also search larger areas and spaces for bar codes. For the search, optimizable functional sequences of the oscillating mirror are also possible (variable deflection for each distance configuration, One-shot) beside the simple deflection at maximum oscillation amplitude.

Line scanner

Scanner deflecting its focussed laser beam by way of a polygon mirror wheel with parallel-axis mirrors at an extremely high speed. In this way, it generates a light dot on the read level running back and forth on a line, and due to its relative inertia, appearing to the human eye as a "static" scan line.

Multiple reading

Selectable number of reads that has to supply identical internal read results (data contents) from exactly the same bar code before the BCL outputs the read result.

No Read format

Special, parameterizable data block replacing every expected and not detected bar code in the data output string of the host interface for a *No Read*. The format consists of a selectable combination of the error string and *separator*.

No Read

In the concluded *reading cycle*, the BCL neither detected any bar code nor the required number of bar codes given by the evaluation conditions set in the parameters.

Object height detection

See distance detection.

One-shot

A directed, single deflection of the oscillating mirror for each *reading cycle*. It primarily consists of a slow forward phase (read) and rapid return phase (return to the starting position).

Opening angle α

The angle within the limits of which the laser beam is deflected by the polygon mirror wheel. Before the reading window, a V-shaped area is formed radially in the scanning direction in which the bar code to be read must be. If only a part of the opening angle is used (part of the scan line is positioned symmetrically around the middle), there will be a larger depth of field range for the same focus position and resolution.

Oscillating mirror reversal point

Point of deflection the oscillating mirror is at in which a reversal of direction takes place. This point can be used to trigger the *focus position switching* for low-speed applications (search function).

Parameter set

Data set with which the implemented functions are initialised and activated in the BCL. It is transferred through upload or download from the BCL to BCL-Config or vice versa.

Pine tree effect

This effect of the *line scanner* with oscillating mirror is a result of the limits set by the active scan line range (CP value) and the oscillation amplitude (CW value). Hence a "sharp window" of the same size can be generated in the reading field for every distance configuration for any read distance.

Read diagnosis data

Data that the BCL derives directly from the read process. With these data, it is possible to assess, among others, the quality of the reading. They are output via the *terminal interface*, always together with the read result.

Read range (DOF)

Depth of field range at both sides of the focal point of the laser beam. The size of the range depends on resolution and read distance.

Read result

Electronic representation of the data contents of the read bar code together with the *read diagnosis data* in a *data output string* after the reading cycle is completed. The read result of the terminal interface has a predefined format for content and output, while the read result of the host interface can be separately configured for Good Read and No Read and have symbols added to it.

Reading cycle

Cycle applied externally to the BCL to trigger the internal *scan gate time*, by way of, for example, a retro-reflective photo electric sensor or as a result of a command from the host via the serial interface.

Reading field height

The length of the *scan line* available for the detection of the bar code on the read level. The length depends on the read distance due to the V principle.

Result status output

Function of the four switched outputs "SWO 1 ... SWO 4" in read mode. The signals indicate the status of the read results, but without displaying its content (e.g. Good Read). The display of the LED "Read Result" is controlled by the output of "SWO 2".

Scan gate time

Time window in which the BCL activates the laser diode and attempts to detect valid bar codes from the information read. Depending on the selected output mode of the read result, the scan gate time may be shorter than the externally applied reading cycle.

Scan line

See line scanner.

Separator

Data block in the read result of the *host interface*. It serves as separating unit between the data contents of the bar codes. It can either precede or follow the bar codes. It contains, depending on configuration, read diagnosis data and/or constants (e.g. alphabets).

Service interface

Auxiliary interface (RS 232) of the BCL with predefined data output format. It is always possible to access the BCL from the PC program BCL-Config via this interface.

Specification diagrams

Diagrams for determining the resolution-dependent depth of field range (DOF) with a predefined focus position.

Standard decoder

Successfully tried and tested *decoder* of the product series BCL. This device is recommended when the bar codes have sufficient code heights, small tilt and good print for reading.

Switching sequence

Function for event-driven focus position switching. Sequence of the focus positions to be adjusted one after the other with the corresponding depths of field. For this purpose, the numbering of the active *distance configurations* is entered in the cross-reference list in the desired position.

Teach-in

The process in which the BCL, in the parameterization mode, is taught the "knowledge" for adapting to the read condition. Example: Background teach-in for the autofocus function, called *distance profile*.

Terminator

Data block in the read result of the *host interface*. It serves to terminate the preceding data content of the bar code. It contains, depending on configuration, read diagnosis data and/or constants (e.g. alphabets).

Time of transmission

Output time of the read result in relation to the beginning of the *reading cycle* and of the internal *scan gate time*.

Upload

The process of transferring the *parameter set* from the BCL to the PC in the user interface of *BCL-Config*. BCL-Config always loads a copy of the current parameter set from the RAM of the BCL. Representation of the parameter values in the tabs. Prerequisite for modifying the current parameter set.

User interface

Windows-based input interface in the PC software BCL-Config for the operation and configuration of the BCL.

1.3 Declaration of Conformity

The BCL 90 has been developed and manufactured in accordance with the applicable European standards and directives.



Notice!

A respective declaration of conformity can be requested from the manufacturer.

The manufacturer of the products, Leuze electronic GmbH + Co. in D-73277 Owen/Teck, has a certified quality assurance system in accordance with ISO 9001.



2 Safety Notices

2.1 Safety Standards

The BCL 90 has been developed, manufactured and tested in accordance with the applicable safety standards. It represents the state of the art.

2.2 Intended Use

**Attention!**

The protection of personnel and the device is not guaranteed if the device is operated in a manner not corresponding to its intended use.

The BCL is used for the automatic detection and decoding of bar codes. It is mounted in a read station and reads, for example, bar codes on objects in a transportation line.

The BCL transmits the data content of the decoded bar code via its host interface to a host for further processing.

Leuze electronic bears no responsibility or liability in the case of any other use and modifications of the device, including those made for the purpose of mounting and electrical installation.

In particular, unauthorised uses include:

- rooms with explosive atmospheres
- operation for medical purposes

Areas of application

The BCL 90 is conceived particularly for the following areas of application:

- Paper-roll identification
- Automobile sector
- Storage and conveying technologies, in particular for object identification on fast-moving conveyor belts
- Pallet transportation applications
- Omnidirectional reading

2.3 Working Safely

**Attention, laser radiation!**

Damage to the eyes through laser radiation!

The BCL operates with a red-light laser of Class 2. Staring at the laser beam may cause damage to the retina.

- Never look at the laser beam directly (same as sunlight).
- Do not point the laser beam of the device to other persons.
- When mounting and adjusting the BCL, heed the reflection of the laser beam on reflective surfaces.
- Do not open the housing.
Opening it does not interrupt the activation of the laser diode through read clocking.
- Heed the laser safety regulations according to DIN EN 60825-1 (most current version).

Laser power

The laser works with a wavelength $\lambda = 650 \text{ nm}$ (visible red light). The maximum output power of the laser beam at the reading window is 2.8 mW.

The exiting radiation is not dangerous to the human skin.

Laser warning signs

The laser warning signs for Europe (Figure 2.1) are at the following locations on the BCL:

- On line scanners, the laser warning symbol is beside the reading window on the front side and the laser warning sign in British/American English is on the same side as the electrical connections.
- On the line scanner with oscillating mirror, the laser warning symbol is above the reading window on the oscillating mirror cover, and the laser warning sign in British/American English is on the same side as the electrical connections.

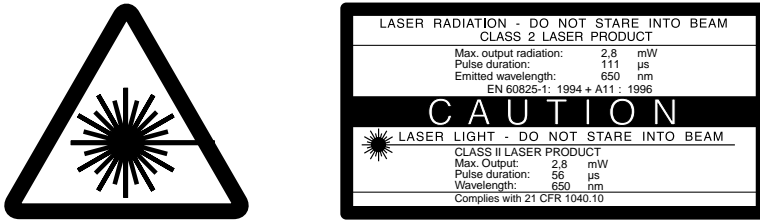

Figure 2.1: Laser warning signs mounted on the BCL



Notice!

The scope of delivery also includes one set of laser warning signs with German/American and French/American versions. If needed, these signs can be used to paste over the British/American English sign.

If the BCL is installed in a machine/sheeting in such a way that the laser warning signs of the device are covered, further warning signs (not in the delivery scope) have to be mounted beside the exit aperture of the laser beam on the machine!

Internal protective circuits

The BCL has monitoring circuits which switch off the laser diode in case irregularities occur in beam generation.

The activation/deactivation of the laser diode during the read process is controlled by read clocking (clock).

10 min. after the start of a continuous reading cycle, a safety circuit (one-shot) automatically switches off the laser diode during read operation under the clocking types "sensor input" and "serial interface", but does not terminate the reading cycle. In this case, the BCL outputs a message via the service interface:

"Laser safety time-out"

The reading cycle is to be terminated through a proper clock signal. The next reading cycle reactivates the laser diode.

The laser diode is permanently switched on in the operating modes "percentage evaluation" "calibrating help" and "show CP limits" as well as in the clocking type "free-oscillating" in reading operation.



Attention!

Access and changes to the device, except where expressly described in this operating manual, are not authorised.

2.4 Organisational Measures

Documentation

All information in this technical description, especially the sections "Safety Notices" and "Commissioning" must by all means be observed.

Keep this technical description in a safe place. It should be accessible at all times.

Safety Regulations

Observe the locally applicable legal regulations and the rules of the employer's liability insurance association.

Qualified Personnel

Mounting, commissioning and maintenance of the device may only be carried out by qualified personnel.

Work on electrical installations may only be carried out by qualified electricians.

Repair

Repairs may only be carried out by the manufacturer or those authorised by the manufacturer.

Environmental Compatibility

The BCL is designed in such a way as to cause minimum harm to the environment. It contains no materials produced using silicone and therefore does not interfere with such processes as e.g. varnish wetting in paint shops.

Energy Requirement

The energy requirement depends on the model:

- the line scanner typically consumes 9 W and a maximum of 16 W power
- the line scanner with oscillating mirror typically consumes 9 W and a maximum of 18 W power
- the line scanner with integrated heater typically consumes 75 W and a maximum of 90 W power
- the line scanner with oscillating mirror and integrated heater typically consumes 75 W and a maximum of 100 W power

These values are based on operation with unconnected switched outputs.

3 Device Description

3.1 The Function of the Device

The BCL detects bar codes using a scan line and decodes them. The BCL transmits the data via the serial host interface to a host/PC for further processing. An overview of the functions of the BCL is shown in Figure 3.1.

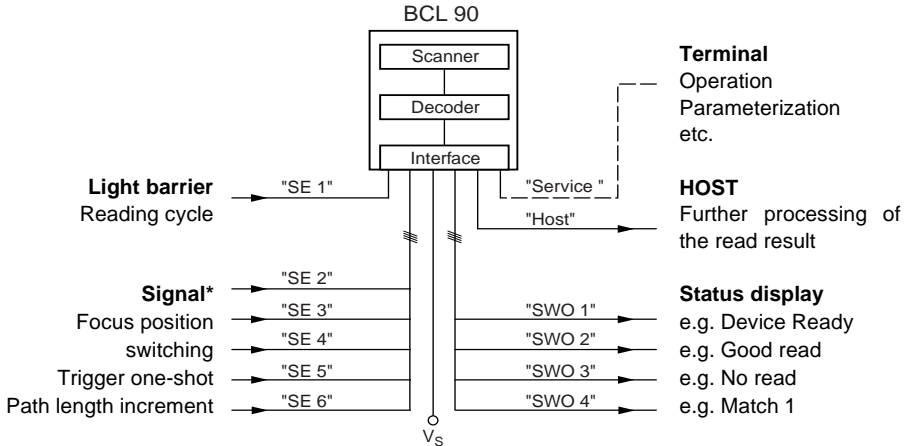

Figure 3.1: Block diagram: functions of the BCL

The BCL offers two decoders:

- the CRT decoder for decoding bar codes with small code heights, of bar codes with damaged or dirty print and for reading extremely tilted bar codes (azimuth angle)
- the tried-and-tested standard decoder of the BCL series

The BCL derives from the read processes useful diagnosis data which can be transferred to the host, and also contains operation data that can be called up. The read quality can be checked in the operating mode percentage evaluation.

The BCL needs a suitable trigger to start a read process as soon as an object is in the reading field. The trigger causes a time window ("scan gate time") to open in the BCL for the read process. In the basic setting, triggering takes place through an external reading cycle sensor. Alternatively, free-oscillating operation or a command via the host interface can also serve as triggers.

Four LED status displays provide optical information on the current operation status.

When triggered externally through a sensor, the switched input "SE 1" informs the BCL when it should start reading. As an alternative to the autofocus function, focus positions can be switched event-driven through the five switched inputs "SE 2 ... SE 6", and the inputs "SE 5" and "SE 6" can additionally be assigned special functions. The four switched outputs "SWO 1 ... SWO 4" can be assigned various output functions of the event status and activate external devices, e.g. a PLC.

The BCL is operated and configured on the user interface of the PC software BCL-Config through the terminal interface (auxiliary interface) or using command strings through the host interface/service interface.

System, warning and error messages provide assistance in set-up/troubleshooting during commissioning and read operation.

3.1.1 Autofocus Function

With the autofocus function, the BCL is capable of detecting the distance of the object in the read process without resorting to external sensors and can independently tune the focus position to the read level of the bar code. To this end, the BCL measures the distance of the object in its field of view in each read, generates an internal distance profile and positions the focal point on the object.

Three operating modes are available for different applications:

- **Smallest distance:** the BCL focusses on the smallest distance in the distance profile. In this case, it neglects the background of its field of view. Applied e.g. for open views on the object, without surrounding structures projecting into the read level.
- **Difference to the background:** the BCL is taught the distance profile of the background of its field of view without object. Then, the BCL focusses during reading on the object it detects by subtracting from the distance profile of the background. Applied e.g. for open views on the object with limits set by structures projecting into the read level.
- **Difference to the background with tracking:** if there are several objects with different distances in the reading field at the same time (distance conflict), the BCL focusses on the previous object below its internal focus position switching. Applied in MSP operation (application with tracking through the Tracking Portal Controller TPC 400).

The generated distance profile of the background can be displayed in BCL-Config. The field of view is defined through the selection of the autofocus range, the opening angle and, in the line scanner with oscillating mirror, additionally through limiting the oscillation amplitude (deflection angle). The parking position (preferred position) of the focus position from which the BCL refocusses in each read can be predefined. The same applies to a time or local lag (time-out or hysteresis). If required, an additional offset can be applied to the focus position which can be adjusted through measurement. In this way, the offset optimises for the object the depth of field which varies radially in the direction of the scan line due to the V principle of beam deflection (Figure 3.2).

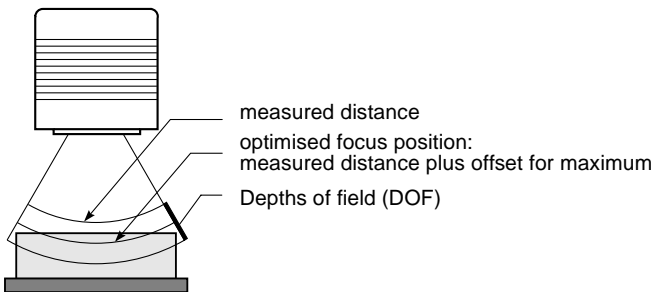

Figure 3.2: Optimisation of the DOF on the object

3.1.2 Event-driven Focus Position Switching

As an alternative to autofocus function, the BCL offers the possibility of an event-driven focus position change, thereby covering a large DOF dynamically. For this purpose, a maximum of eight depths of field can be defined as distance configurations and focussed on by the optical system in random sequence in read operation (Figure 3.3).

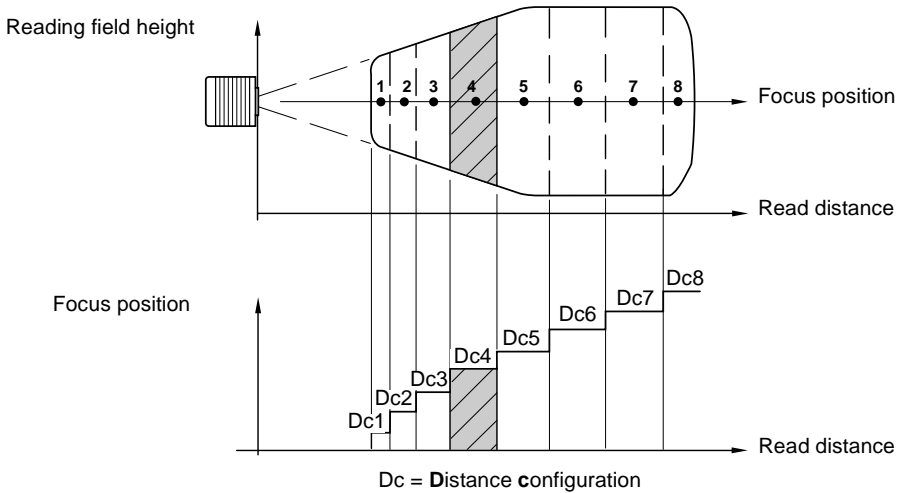

Figure 3.3: Focus position switching: dividing the DOF into distance configurations

A switch is made whenever the object distance changes (when reading downwards: object height detection). A combination of signals from the switched inputs "SE 2 ... SE 6", a command to the host interface/service interface or the integrated timer (e.g. for the search function) serve to trigger the switch. In the line scanner with oscillating mirror, the oscillating mirror reversal points of the bilateral deflections also have a trigger function. The distance configurations are assigned to the switching sequence by a programmable cross-reference list. The distance measurement of the autofocus function can also be used to assist in defining the distance configurations.

3.1.3 Variants of the Scanning Process

Line scanner (standard device)

It generates a scan line. The reading field height (the scan line length useful for evaluation) depends on the read distance due to the V principle of beam deflection.

Line scanner with oscillating mirror

The oscillating mirror deflects the scan line additionally to both sides across the scan direction at a low oscillation frequency. In this way, the BCL can also scan larger areas or spaces for bar codes. The reading field height (the scan line length useful for evaluation) depends on the read distance due to the V principle of beam deflection.

Aside from parking (fixed position) and the simple deflection at maximum oscillation amplitude, optimised course of function of the oscillating mirror are also possible:

- oscillating at variable oscillation amplitude for each distance configuration
- one-shot: single, defined deflection for each reading cycle (forward and return phase)

3.1.4 Other Components

For information on technical data and features of the connector unit, refer to the data sheet MA 90.

BCL 90 "stand alone"

The bar code reader BCL 90 is operated as a "stand-alone" device. The BCL 90 provides two 15-pin Sub-HD connectors for the supply voltage, the interface and the switched inputs.

BCL 90 with MA 90

The connector unit MA 90 offers simple electrical installation in conjunction with the BCL 90. We recommend the connector unit MA 90 for each BCL 90 if several BCL are to be networked. It is user-friendly in terms of electrical connection, commissioning and maintenance requiring minimum time input. BCL 90 and MA 90 are arranged separately. The two devices are connected by cable.

Heater

For low-temperature applications to a maximum of -35°C (e.g. in cold storage) an optional heater can be permanently installed in the BCL. (See below)

External parameter memory

The external parameter memory is located in a plug cover beneath which are the two electrical connectors of the BCL after mounting (IP 65). By having available a copy of the current parameter set of the BCL, the parameter memory makes it easy and reduces the time needed to replace the BCL on site. A manual configuration of the exchanged device is thereby omitted.

For application and operation see Section 5.1.1, on page 65.

Optional heater

Features:

- Integrated heater (permanently installed)
- Expansion of the area of application of the line scanner to a maximum of -35 °C (Line scanner with oscillating mirror to a maximum of -35 °C)
- Supply voltage DC 24 V +20%/-10%
- BCL enabling through an internal temperature switch (switch-on delay about 35 ... 40 min for DC 24 V and minimum ambient temperature of -35°)
- required core cross-section (supply voltage): at least 0.75 mm²

Structure:

The heater consists of two parts:

- the front cover heater
- the housing heater

The optional heater is installed and tested to order in the factory. The user cannot install it on site.

Function:

When the supply voltage DC 24 V is applied to the BCL, a temperature switch initially only connects the heater to electrical power. During the heating phase (around 35 min), when the inside temperature rises above 7 °C, the temperature switch connects the BCL to the supply voltage. This is followed by the selftest and the changeover to read operation. The LED "Device Ready" lights up showing overall readiness for operation.

When the inside temperature reaches around 25 °C, another temperature switch turns off the housing heater to reconnect it when needed. This does not interrupt the read operation. The front cover heater remains permanently activated. Figure 3.4 shows a diagram of temperature variation in the housing.

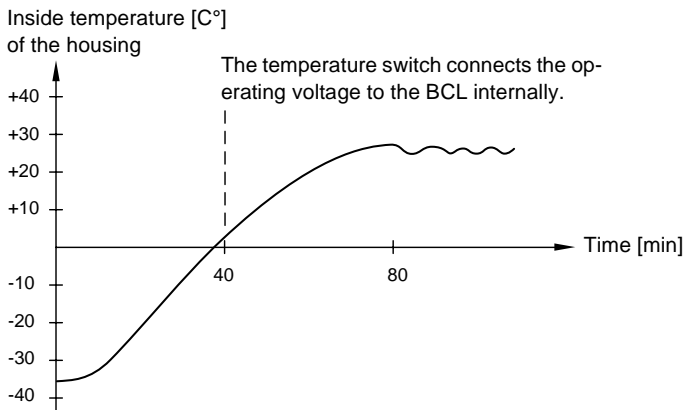

Figure 3.4: BCL with heater: diagram of temperature variation in the housing

Electrical connection:

Core cross-section

The required core cross-section of the connection cable for the supply voltage must be at least 0.75 mm². (Also see Section 7.4.2, on page 83)

Power consumption

The energy requirement depends on the model:

- the line scanner with heater typically consumes 75 W and a maximum of 90 W power.
- the line scanner with oscillating mirror and integrated heater typically consumes 75 W and a maximum of 100 W power.

These values apply to operation with unconnected switched outputs.

Outdoor application:

If the BCL with integrated heater is to be operated outdoors, we recommend installing the BCL in an additional protective housing. This would prevent the front cover becoming dirty with rain, snow or dust. At the same time, the housing would serve as protection against wind.

3.1.5 Networking

Up to 31 scanners can be networked via the connector unit MA 90 and a bus master MA 31. For this, every BCL 90 is assigned its own hardware address in the corresponding MA 90. The networking is carried out through a parallel connection of the individual RS 485 interfaces.

multiNet plus

In the Leuze proprietary multiNet plus, the bus nodes transmit their data one after the other upon request by the network master MA 31. In addition, every bus node declared a slave receives a device address which is adjusted in the corresponding MA 90 via a coding switch. The device address remains in the MA 90 when the scanner is replaced. The master then transmits the data of all bus nodes via its host interface to a primary PLC control or a computer, i.e. it "collects" the scanner data in the network and transmits them via an interface to the host computer. This reduces interface costs (CPs) and time spent programming the software.

Networking via multiNet plus

Slave 1

BCL 90 / MA 90

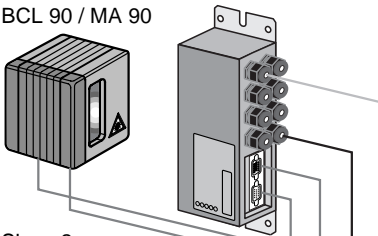

Slave 2

BCL 90 / MA 90

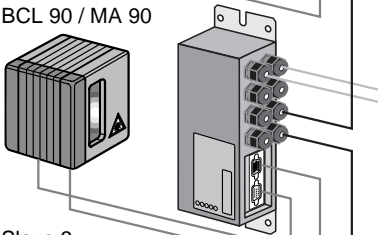

Slave 3

BCL 90 / MA 90

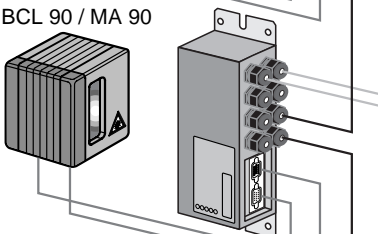

Host
(PLC, process, etc.)

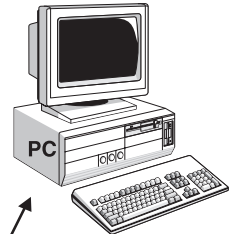
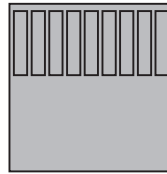

- Backup
- Parameter

RS 232
RS 422
RS 485
or
TTY

Network master
multiNet plus

Voltage supply

MA 30/31

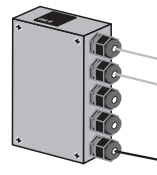

RS 485

Figure 3.5: Networking possibilities via multiNet plus (BCL 90)

Two-wire RS 485

The Leuze multiNet plus is optimised for fast transmission of scanner data to a primary host computer. Physically, it consists of a two-wire RS 485 interface controlled by a software protocol, the multiNet plus protocol. This makes wiring the network easy and inexpensive as slaves are connected to one another in parallel.

Interface module

Shielded, twisted pair conductors should be used for the multiNet. This allows a total network length of up to 1200 m. The network is connected to the primary computer via the host interface of MA 31, which can be equipped with four different physical interface modules. The available options are modules for RS 422, RS 232, TTY or RS 485.

3.2 Device Structure

3.2.1 Scope of Delivery

Beside the BCL, the **device packaging** also includes:

- an information sheet (device information) with electrical connection diagram and quick-start
- an extra set of laser warning signs (self-adhesive) of Class 2 in German/American English and French/American English

Depending on the **number of devices ordered** one **set of technical documentation** in one or several copies, comprised of:

- this operating manual BCL 90 in German or English
- one set of DOS-formatted diskettes (3.5 inch) with the PC software BCL-Config for Windows.

Chapter 5, on page 65 gives an overview of available accessories for the device, electrical connections and mounting as well as connection modules and cables.

3.2.2 Device Models

Several BCL models are available:

Model (red light)	Order number	Scan technology	Reading window	Heater
BCL 90 CAT M 100	500 35 314	Line scanner	frontal	no
BCL 90 CAT OM 100	500 35 315	Line scanner with oscillating mirror	lateral	no
BCL 90 CAT M 100 H	500 35 316	Line scanner	frontal	yes
BCL 90 CAT OM 100 H	500 35 317	Line scanner with oscillating mirror	lateral	yes
BCL 90 CAT N 100	500 35 507	Line scanner	frontal	no
BCL 90 CAT ON 100	500 35 508	Line scanner with oscillating mirror	lateral	no
BCL 90 CAT N 100 H	500 35 509	Line scanner	frontal	yes
BCL 90 CAT ON 100 H	500 35 510	Line scanner with oscillating mirror	lateral	yes
BCL 90 CAT F 100	500 35 318	Line scanner	frontal	no
BCL 90 CAT OF 100	500 35 511	Line scanner with oscillating mirror	lateral	no
BCL 90 CAT F 100 H	500 35 512	Line scanner	frontal	yes
BCL 90 CAT OF 100 H	500 35 513	Line scanner with oscillating mirror	lateral	yes

Table 3.1: Variants of the BCL

3.2.3 System Requirements

BCL without heater

The following are required for commissioning and operating the BCL:

1. A modular connector unit MA 90 for power supply and wiring-up of data and function interfaces.
- or -
 Alternatively, an external power supply unit with an output voltage of DC +18 ... +30 V acc. to IEC 742 (functional low voltage) and at least **20 W** output power.
 Connecting cable No. 500 35 321 (3 m) with 15-pin D-Sub-HD plug and open cable end for connecting the BCL to the external power supply unit.
2. The operating voltage/output power is as follows:
 - MA 90: DC +18 ... +30 V (acc. to IEC 742), at least 20 W
3. for switched input "SE 1" for external read clocking: a suitable reading cycle sensor to report an object with bar code, e.g. a retro-reflective photo electric sensor.
4. for switched inputs "SE 2 ... SE 6" to detect the object distance: suitable sensors for multistage focus position switching, e.g. retro-reflective photo electric sensor.
5. a PC with Windows®9x/ME or Windows NT®/2000 and serial interface (port "COM x").
6. an RS 232 data connection cable with two 9-pin D-Sub sockets to connect the PC to the BCL service interface in the MA 90.
 Pin 2 (Rx/D) and Pin 3 (Tx/D) are crossed.

BCL with heater

The following are required for commissioning and operating the BCL:

1. A modular connector unit MA 90 for power supply and wiring-up of data and function interfaces.
- or -
 Alternatively, an external power supply unit with an output voltage of DC 24 V +20%/-10% acc. to IEC 742 (functional low voltage) and at least 100 W output power.
 Connecting cable No. 500 35 321 (3 m) with 15-pin D-Sub-HD plug and open cable end for connecting the BCL to the external power supply unit.
2. The operating voltage/output power is as follows:
 - MA 90: DC 24 V + 20% / - 10% (acc. to IEC 742), at least 100 W
3. The remaining data are the same as the part starting from item 3 under BCL without heater

3.2.4 View of the Device



Line scanner
(frontal reading window)



Line scanner with oscillating mirror
(lateral reading window)

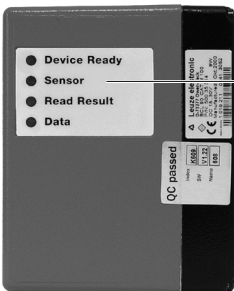
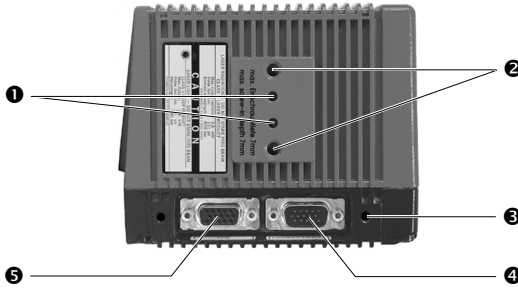

- ❶ Fitting hole, \varnothing 3.6 mm, 6 mm deep
- ❷ Fastening threads M6, 7 mm deep, for fastening

- ❸ Fastening threads M4, 10 mm deep, for plug cover
- ❹ "Host/Term" connection

- ❺ "I/O" connection
- ❻ LED function displays
- ❼ Reading window

Figure 3.6: Structure of the BCL 90

4 Technical Data

4.1 Technical Data

4.1.1 Data Sheet BCL 90 CAT M 100 / BCL 90 CAT N 100 / BCL 90 CAT F 100

Model	BCL 90 CAT M 100 Medium Density	BCL 90 CAT N 100 High Density	BCL 90 CAT F 100 Low Density
Type	Line scanner, without heater		
Reading window	frontal		
Laser diode (wavelength)	red light ($\lambda= 650$ nm)		
Service life of the laser diode	MTBF 20,000 h		
Laser class of the device	Class 2 (acc. to DIN EN 60825-1), safety disconnection of the laser diode after 10 min ¹⁾		
Focus control	autofocus, alternatively event-driven focus position switching		
Number of distance configurations	max. 8		
Focus adjustment time	≤ 20 ms (typically)		
Focus trigger	switched inputs "SE 2... SE 6"/ data interface/ timer		
Useful opening angle	max. 60° (frontal reading window)		
Scanning/decoding frequency	600 ... 1200 Hz		
Resolution	0.25 ... 1.0 mm	0.17 ... 0.4 mm	0.35 ... 1.2 mm
DOF	see reading field diagram starting from page 34		
Bar code print contrast (PCS)	≥ 60%		
External light tolerance	2000 lx (on bar code)		
Number of bar codes per scan	1 ... 12 (standard decoder), 1 ... 5 (CRT decoder)		
Number of bar codes per scan gate time ²⁾	1 ... 50 (auto-discriminating)		
Types of bar code (CRT decoder)	Code 39, Code 128, Code 93, Codabar, EAN, EAN 128, UPC, 2/5 Interleaved		
Bar code length	max. 50 characters (max. 600 characters for all bar codes per scan gate time taken together)		
Print ratio	2:1 ... 3:1		
Number of multiple readings	1 ... 99		
Optical indicators	4 LED function indicators		
Read clocking	switched input "SE 1"/ free-oscillating/ serial interface/ MSP/TCP		
Data interface "host"	RS 232 or RS 422/485, adjustable data output format		
Data transmission rate	300 ... 57 600 bits/ s		
Protocols	Leuze standard, Leuze network multiNet plus and 3964(R)		
Physical configurations	stand alone, network (bus)		
Data interface "service"	RS 232, 9600 baud, 8 data bits, no parity, 1 stop bit, predefined output format		

Table 4.1: Technical specifications BCL 90 CAT **M** 100 / **N** 100 / **F** 100

Model	BCL 90 CAT M 100 Medium Density	BCL 90 CAT N 100 High Density	BCL 90 CAT F 100 Low Density
Function switched inputs	6 ("SE 1 ... SE 6") - with opto-coupler, $U_{\text{emax}} = +30 \text{ V}$, polarity-proof, can be connected to p-n-p outputs - "SE 1" (reading cycle): max. internal delay time 30 ms, reduced max. 2 ... 6 ms - "SE 2 ... SE 6": focus position switching, IN 3 and IN 4: selectable function int. delay time max. 30 ms		
Function switched outputs	4 ("SWO 1" ... "SWO 4") - p-n-p, short-circuit proof, adjustable pulse duration (statical, resolution 10 ... 990 ms or 100 ... 9900 ms) - function of the result status indication selectable		
Electrical connections	1 x 15-pin D-Sub-HD device plug, 1 x 15-pin D-Sub-HD device socket		
Operating voltage/ power consumption	DC 18 ... 30 V/ typically 9 W, max. 16 W		
Housing	Aluminium die-cast, no silicone used in the exterior materials		
Type of protection/ safety class	IP 65 ³⁾ (acc. to DIN 40 050)/ Class 3 (acc. to VDE 0106/IEC 1010-1)		
EMC/ vibration/ shock testing	acc. to IEC 801/ acc. to IEC 68-2-6 Test FC/ acc. to IEC 68-2-27 Test EA		
Weight	around 1.5 kg		
Operating ambient/ storage temperature	0 ... +40 °C/ -40 ... +70 °C		
Max. relative air humidity	90%, non-condensing		
¹⁾ In read operation under the clocking types "switched input sensor" and "serial interface" ²⁾ Scan gate time: time window of code evaluation generated internally through the reading cycle ³⁾ Including plug cover or plug cover with parameter memory			

Table 4.1: Technical specifications BCL 90 CAT M 100 / N 100 / F 100 (Cont.)

4.1.2 Data Sheet BCL 90 CAT OM 100, BCL 90 CAT ON 100, BCL 90 CAT OF 100

Technical data same as BCL 90 CAT M/N/F 100 except for the following deviations:

Model	BCL 90 CAT OM 100 /BCL 90 CAT ON 100 /BCL 90 CAT OF 100
Type	Line scanner with oscillating mirror
Reading window	lateral
Light exit	at an angle of 105°
Focus trigger	additionally: oscillating mirror reversal points
Useful opening angle	max. 50°
Oscillating mirror functions	stationary, oscillating (variable or predefined amplitude), one-shot ¹⁾
Oscillation frequency	0.2 ... 4 Hz
Max. deflection angle	max. ± 20° (± 40 CW), adjustable through the software
DOF	see reading field diagram starting from page 40
Deflection widths	see Figure 4.15, on page 46
Operating voltage/ power consumption	DC 18 ... 30 V/ typically 9 W, max. 18 W
Weight	around 2.2 kg
¹⁾ One-shot: single oscillation per reading cycle (starting position and speed for forward and return phase selectable)	

Table 4.2: Technical specifications BCL 90 CAT OM 100 / ON 100 / OF 100

4.1.3 Data Sheet BCL 90 CAT M 100H, BCL 90 CAT N 100H, BCL 90 CAT F 100H

Technical data same as BCL 90 CAT M/N/F 100 except for the following deviations:

Model	BCL 90 CAT M 100 H / BCL 90 CAT N 100 H / BCL 90 CAT F 100 H
Type	Line scanner with heater
Switch-on behaviour/ temperature variation	see “Optional heater” on page 21
Switch-on delay	35 ... 40 min (for DC 24 V and min. ambient temp. of -35°)
Operating voltage	DC 24 V +20% / -0%
Power consumption	typically 75 W, max. 90 W
Required core cross-section	at least 0.75 mm ² (for operating voltage supply)
Weight	around 1.5 kg
Operating ambient/ storage temperature	-35 ... +35 °C / -20 ... +70 °C

Table 4.3: Technical specifications BCL 90 CAT M 100H / N 100H / F 100H

4.1.4 Data Sheet BCL 90 CAT OM 100H, BCL 90 CAT ON 100H, BCL 90 CAT OF 100H

Technical data same as BCL 90 CAT OM/ON/OF 100 except for the following deviations:

Model	BCL 90 CAT OM 100 H / BCL 90 CAT ON 100 H / BCL 90 CAT OF 100 H
Type	Line scanner with oscillating mirror and heater
Switch-on behaviour/ temperature variation	see "Optional heater" on page 21
Switch-on delay	35 ... 40 min (for DC 24 V and min. ambient temp. of -25°)
Operating voltage	DC 24 V +20% / -10%
Power consumption	typically 75 W, max. 100 W
Required core cross-section	at least 0.75 mm ² (for operating voltage supply)
Weight	around 2.2 kg
Operating ambient/ storage temperature	-35 ... +35 °C / -20 ... +70 °C

Table 4.4: Technical specifications BCL 90 CAT OM 100H / ON 100H / OF 100H

4.2 Dimensioned Drawings

4.2.1 Line Scanner (Standard Device) with/without Heater

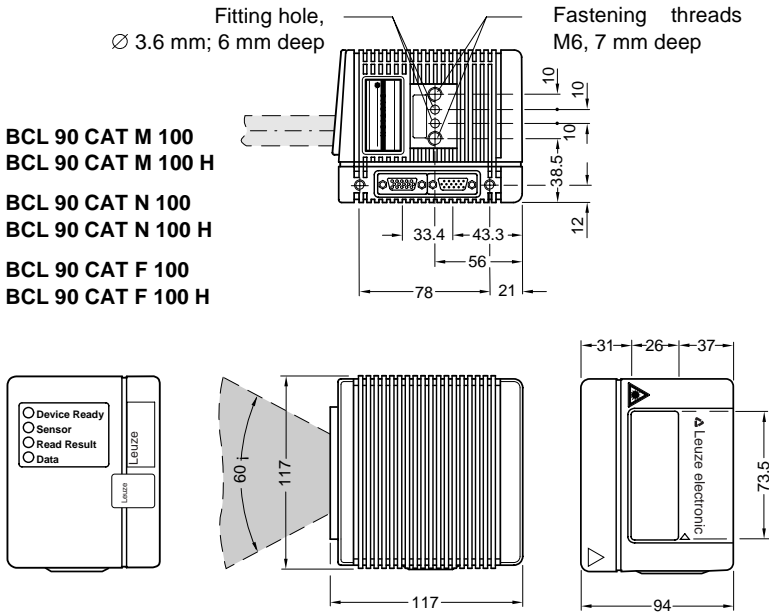

Figure 4.1: Dimensions of the BCL 90 (line scanner), frontal reading window

4.2.2 Line Scanner with Oscillating Mirror (with/ without Heater)

All data in mm

- BCL 90 CAT OM 100
- BCL 90 CAT OM 100 H
- BCL 90 CAT ON 100
- BCL 90 CAT ON 100 H
- BCL 90 CAT OF 100
- BCL 90 CAT OF 100 H

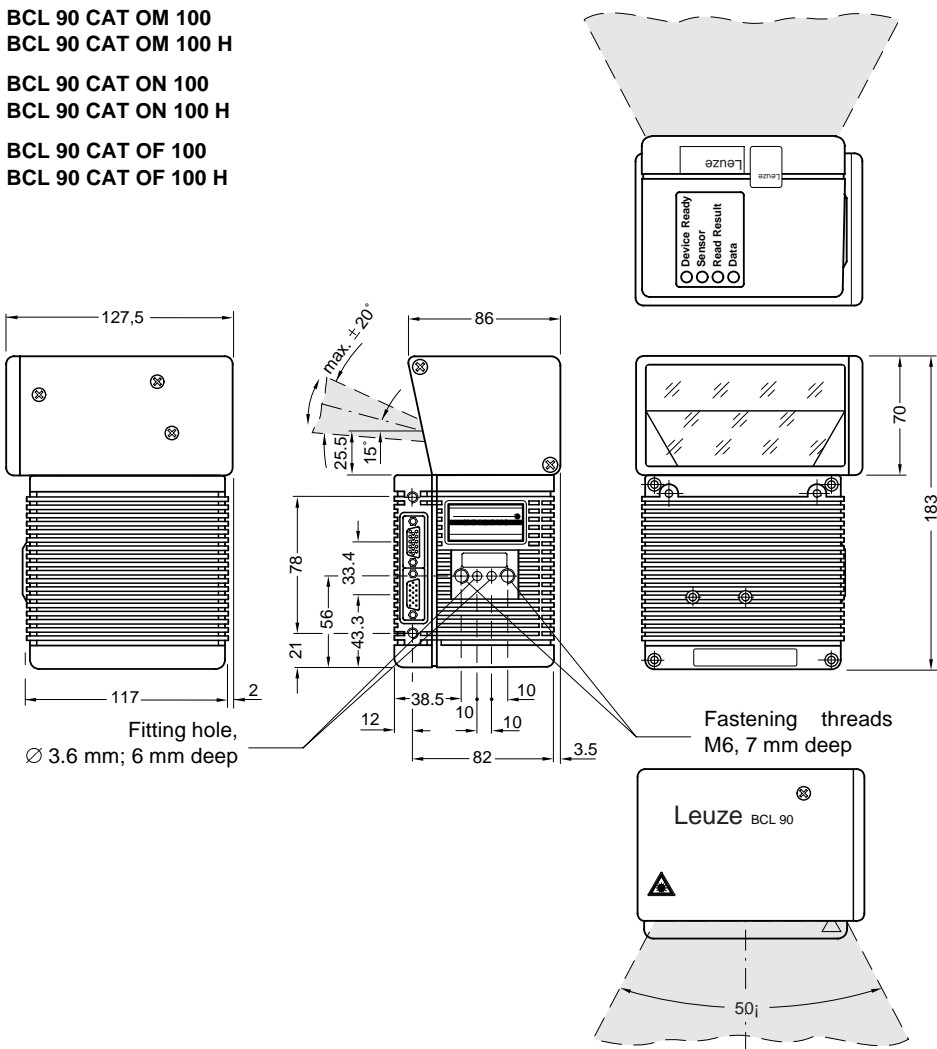

Figure 4.2: Dimensions of the BCL 90 (line scanner with oscillating mirror), lateral reading window

4.3 Optical Data (Specification Diagrams)

4.3.1 Reading Conditions for All Diagrams

Test code	Code 128
Print contrast	> 90%
Tilt	± 45°
External light	< 2000 lx
Good Read rate	> 75%

Table 4.5: Reading conditions for specification diagrams



Notice!

Min. and max. read distances are measured radially from the BCL!

4.3.2 Overview of Diagrams

Line scanners

Model	Diagrams	Page
BCL 90 CAT M 100/M 100H:	Variation of reading field height with read distance and resolution	34
	Variation of min. and max. read distance with focus position (resolution 0.35 mm, opening angle 40°)	35
	Variation of min. and max. read distance with focus position (resolution 0.35 mm, opening angle 56°)	36
	Variation of min. and max. read distance with focus position (resolution 0.50 mm, opening angle 40°)	37
	Variation of min. and max. read distance with focus position (resolution 0.50 mm, opening angle 56°)	38
	Characteristics of scanning frequency variation with read distance and resolution	39
BCL 90 CAT N 100/N 100H:	Variation of reading field height with read distance and resolution	47
	Variation of min. and max. read distance with focus position (resolution 0.25 mm, opening angle 40°)	48
	Variation of min. and max. read distance with focus position (resolution 0.35 mm, opening angle 40°)	49
	Variation of min. and max. read distance with focus position (resolution 0.35 mm, opening angle 56°)	50
	Characteristics of scanning frequency variation with read distance and resolution	51

Table 4.6: Overview of specification diagrams of line scanners

Model	Diagrams	Page
BCL 90 CAT F 100/F 100H:	Variation of read field height with read distance and tilt at 0.5 mm resolution	58
	Variation of min. and max. read distance with focus position (resolution 0.50 mm, opening angle 40°)	59
	Variation of min. and max. read distance with focus position (resolution 0.50 mm, opening angle 60°)	60
	Characteristics of scanning frequency variation with read distance and resolution	61

Table 4.6: Overview of specification diagrams of line scanners (Cont.)

Line scanners with oscillating mirrors

Model	Diagrams	Page
BCL 90 CAT OM 100/OM 100H:	Variation of reading field height with read distance and resolution	40
	Variation of min. and max. read distance with focus position (resolution 0.35 mm, opening angle 40°)	41
	Variation of min. and max. read distance with focus position (resolution 0.35 mm, opening angle 50°)	42
	Variation of min. and max. read distance with focus position (resolution 0.50 mm, opening angle 40°)	43
	Variation of min. and max. read distance with focus position (resolution 0.50 mm, opening angle 50°)	44
	Characteristics of scanning frequency variation with read distance and resolution	45
	Variation of deflection width with read distance, deflection angle and resolution	46
BCL 90 CAT ON 100/ON 100H:	Variation of reading field height with read distance and resolution	52
	Variation of min. and max. read distance with focus position (resolution 0.25 mm, opening angle 40°)	53
	Variation of min. and max. read distance with focus position (resolution 0.35 mm, opening angle 40°)	54
	Variation of min. and max. read distance with focus position (resolution 0.35 mm, opening angle 56°)	55
	Characteristics of scanning frequency variation with read distance and resolution	56
	Variation of deflection width with read distance, deflection angle and resolution	57
BCL 90 CAT OF 100/OF 100H:	Variation of reading field height with read distance and tilt at 0.50 mm resolution	62
	Characteristics of scanning frequency variation with read distance and resolution	63
	Variation of deflection width with read distance, deflection angle and tilt at 0.50 mm resolution	64

Table 4.7: Overview of specification diagrams of line scanners with oscillating mirrors

4.3.3 Medium Density: Reading Performance Data of Line Scanner

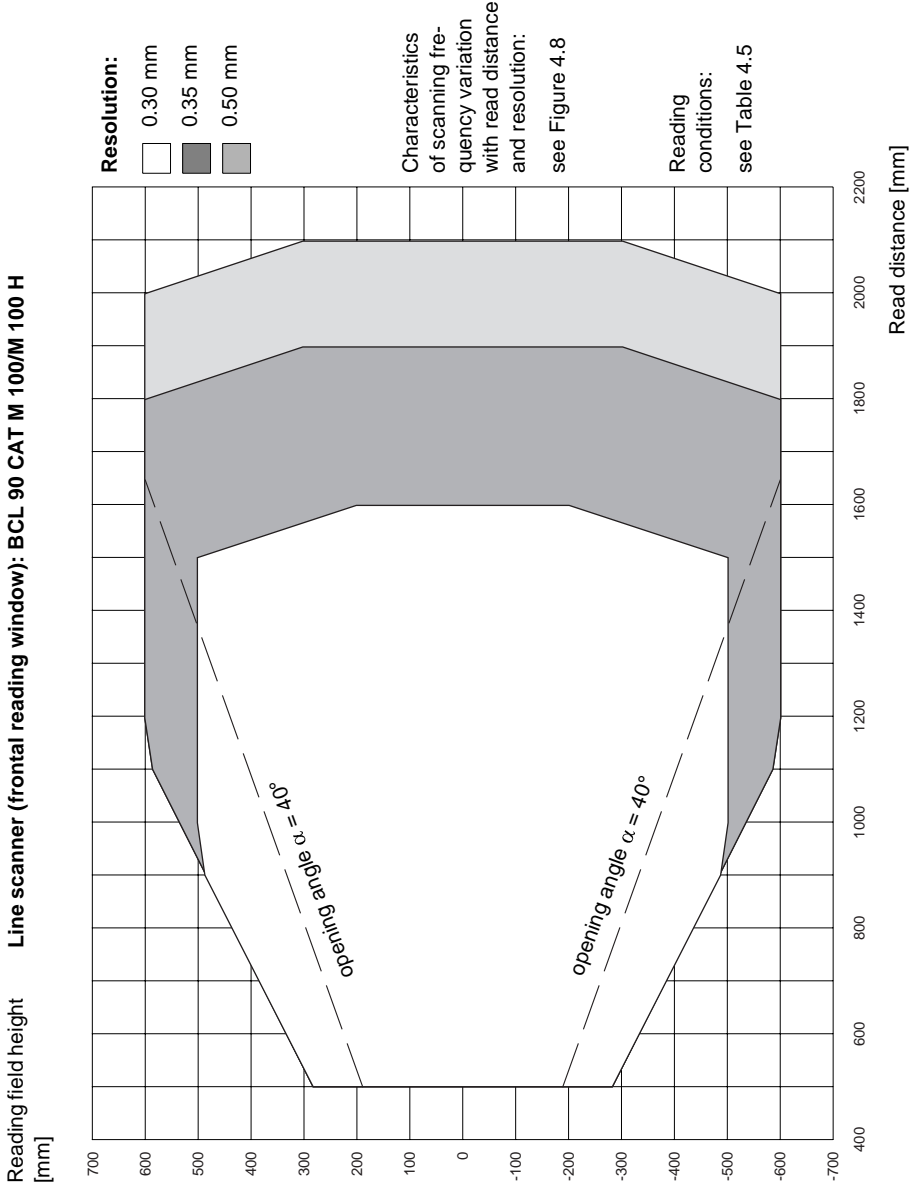

Figure 4.3: BCL 90 CAT M 100/M 100 H (medium density): variation of reading field height with read distance and resolution

Line scanner (frontal reading window): BCL 90 CAT M 100/M 100 H

Resolution: 0.35 mm

Opening angle: 40°

Read distance [mm]

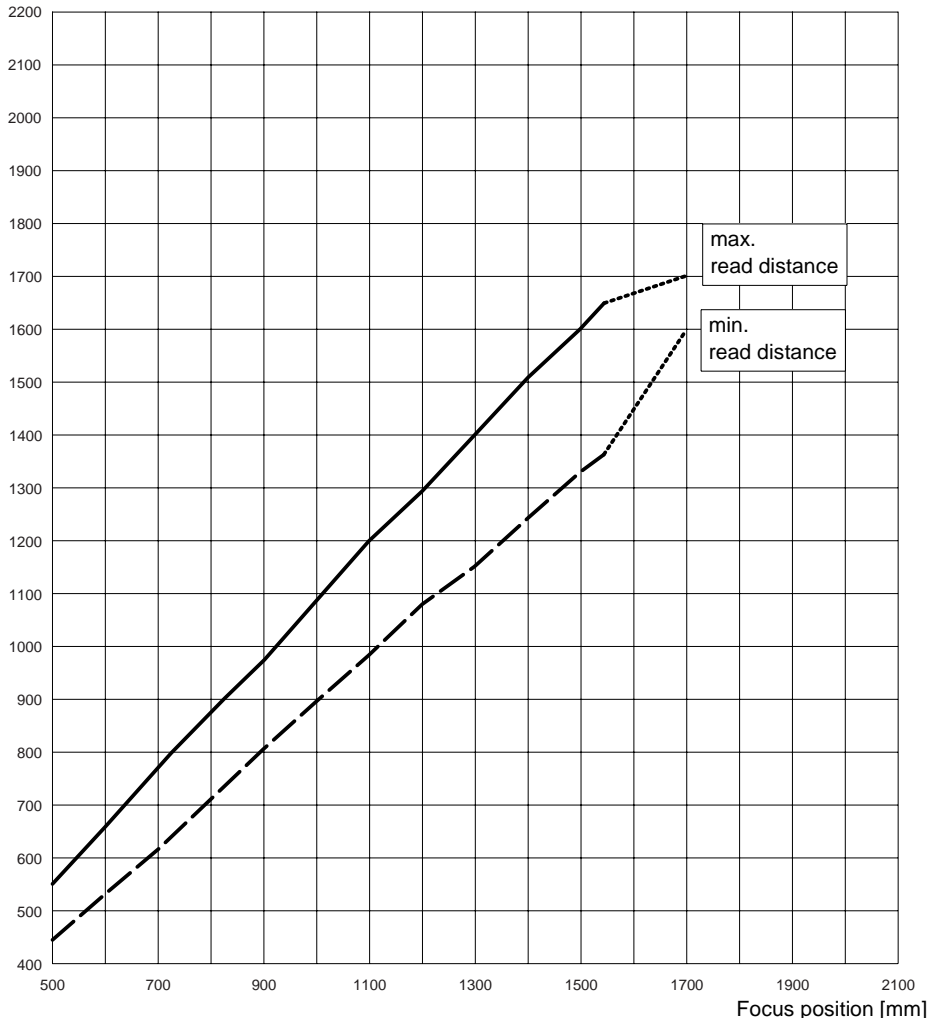

Characteristics of scanning frequency variation with read distance and resolution:
see Figure 4.8

Reading conditions:
see Table 4.5

Figure 4.4: BCL 90 CAT M 100/M 100 H (medium density): variation of min. and max. read distance (radially measured) with focus position at 0.35 mm resolution and opening angle $\alpha = 40^\circ$

Line scanner (frontal reading window): BCL 90 CAT M 100/M 100 H

Resolution: **0.35** mm

Opening angle: **56°**

Read distance [mm]

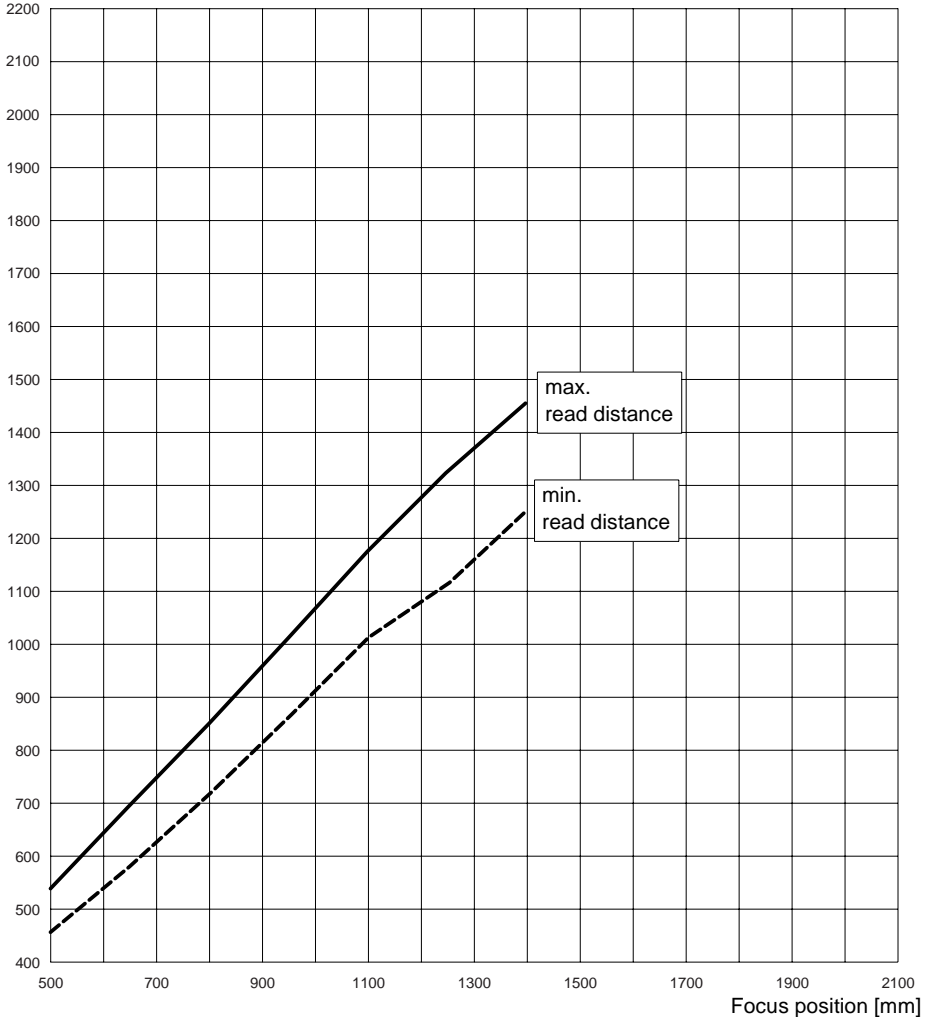

Characteristics of scanning frequency variation with read distance and resolution:
see Figure 4.8

Reading conditions:
see Table 4.5

Figure 4.5: BCL 90 CAT M 100/M 100 H (medium density): variation of min. and max. read distance (radially measured) with focus position at 0.35 mm resolution and opening angle $\alpha = 56^\circ$

Line scanner (frontal reading window): BCL 90 CAT M 100/M 100 H

Resolution: 0.50 mm

Opening angle: 40°

Read distance [mm]

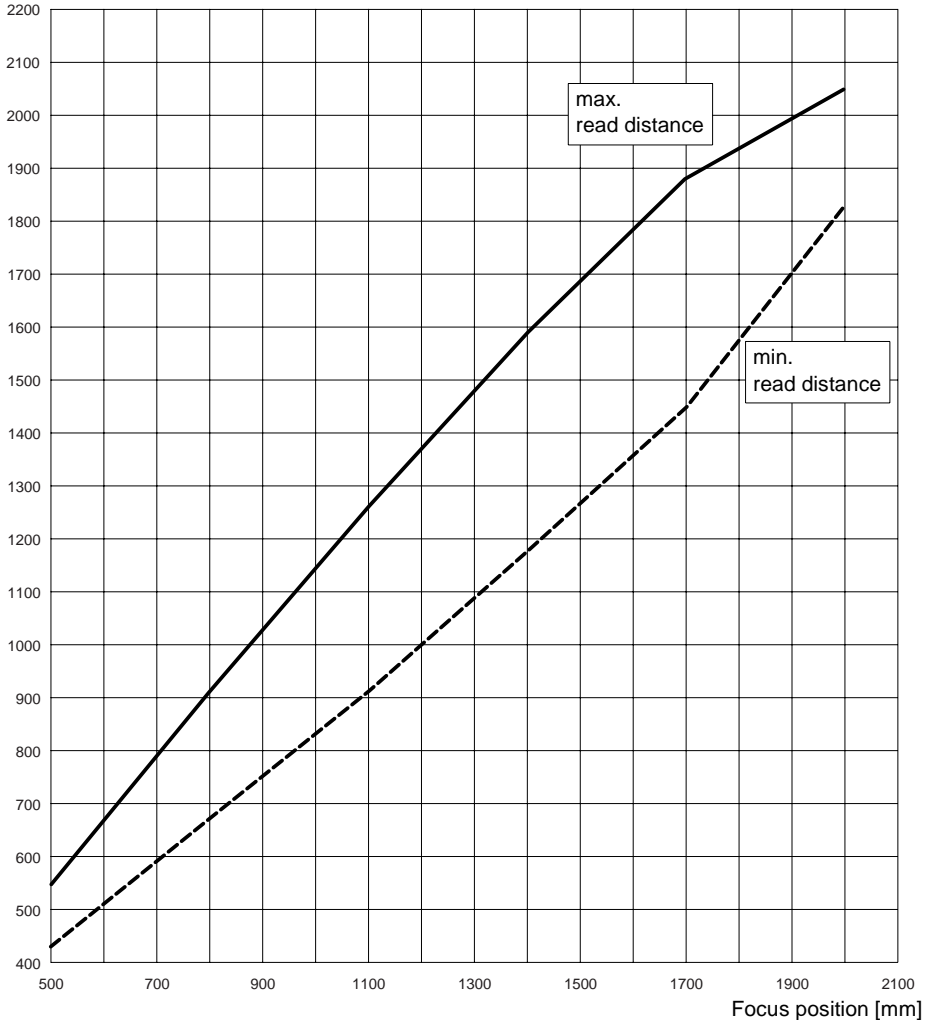

Characteristics of scanning frequency variation with read distance and resolution:
see Figure 4.8

Reading conditions:
see Table 4.5

Figure 4.6: BCL 90 CAT M 100/M 100 H (medium density): variation of min. and max. read distance (radially measured) with focus position at 0.50 mm resolution and opening angle $\alpha = 40^\circ$

Line scanner (frontal reading window): BCL 90 CAT M 100/M 100 H

Resolution: **0.50 mm**

Opening angle: **56°**

Read distance [mm]

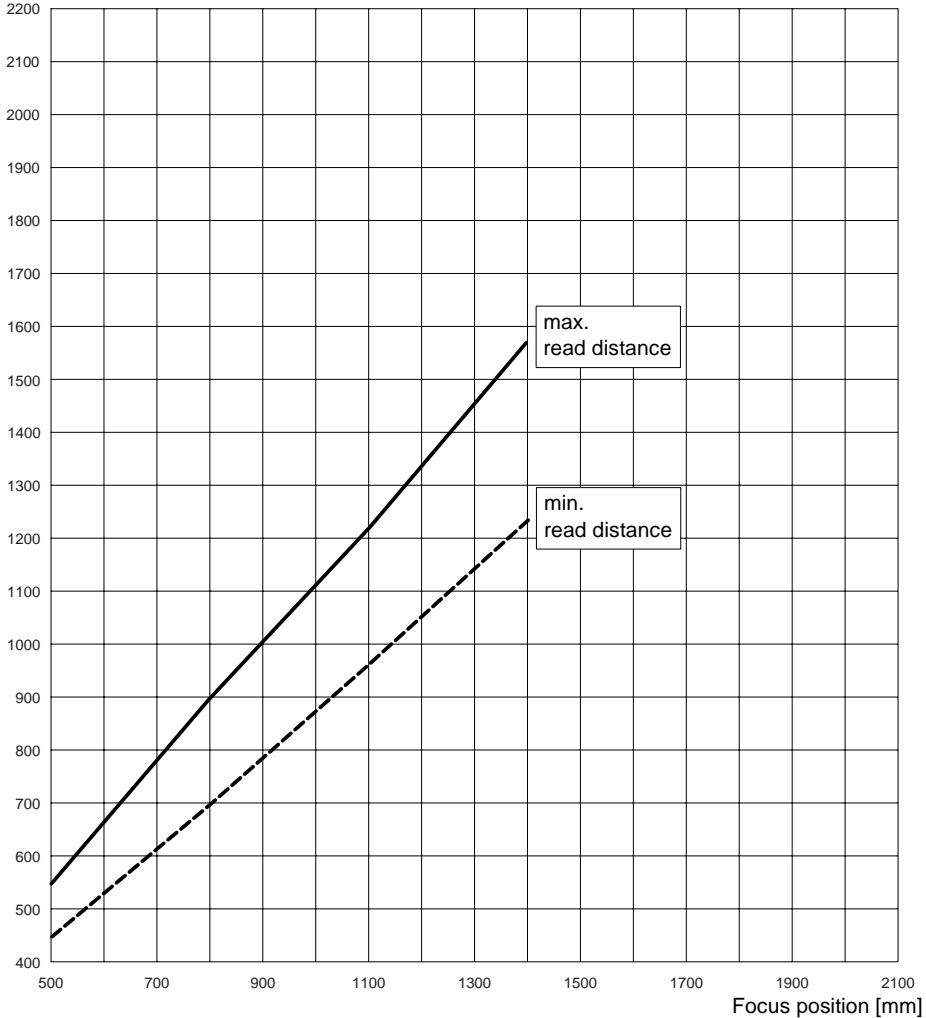

Characteristics of scanning frequency variation with read distance and resolution:
see Figure 4.8

Reading conditions:
see Table 4.5

Figure 4.7: BCL 90 CAT M 100/M 100 H (medium density): variation of min. and max. read distance (radially measured) with focus position at 0.50 mm resolution and opening angle $\alpha = 56^\circ$

Line scanner (frontal reading window): BCL 90 CAT M 100/M 100 H

Scanning frequency [Hz]

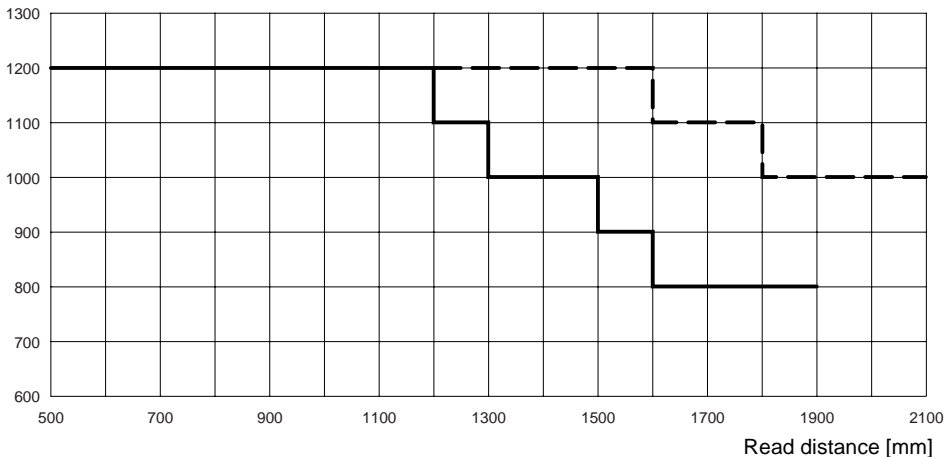

Resolution:

———— 0.35 mm

- - - - - 0.50 mm

Reading conditions:

see Table 4.5

Figure 4.8: BCL 90 CAT M 100/M 100 H (medium density): characteristics of scanning frequency variation with read distance and resolution

4.3.4 Medium Density: Reading Performance Data of Line Scanner with Oscillating Mirror

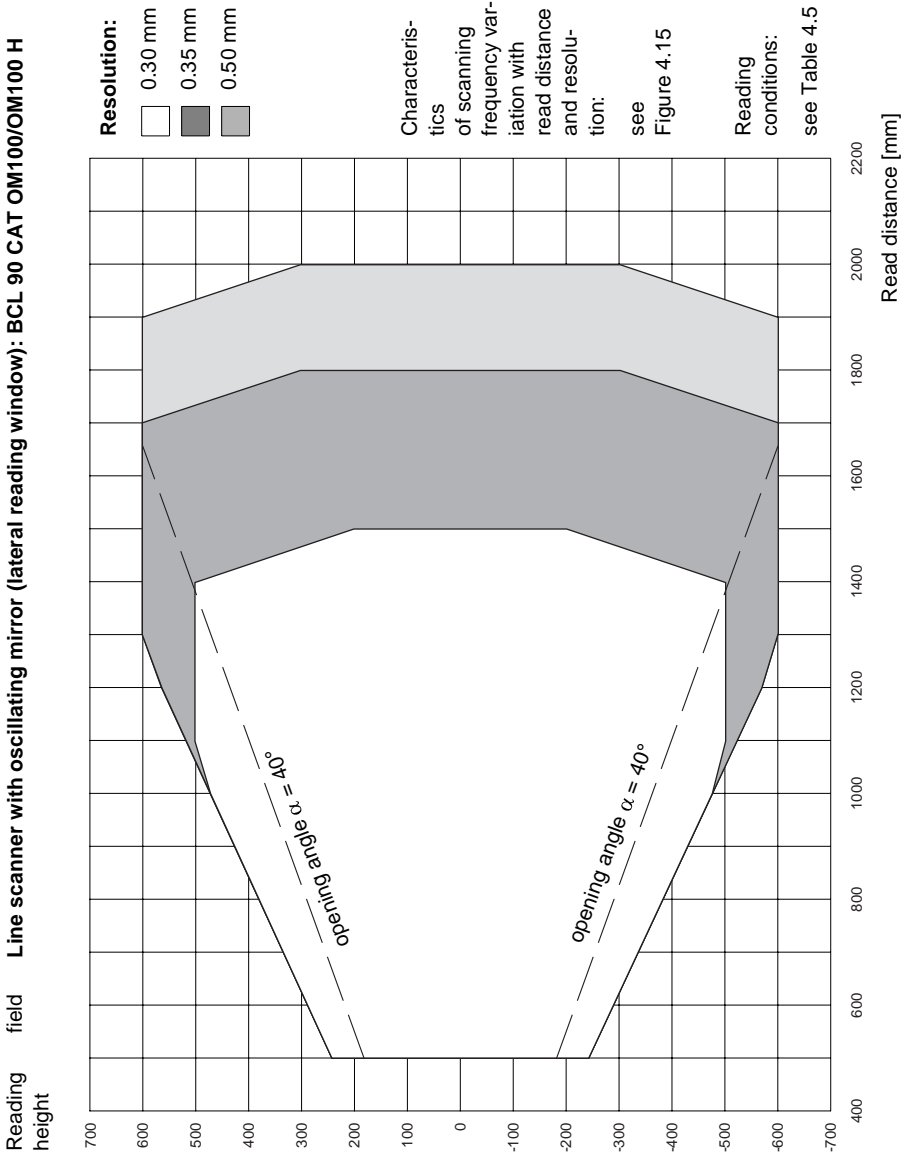

Figure 4.9: BCL 90 CAT OM 100/M 100 H (medium density): variation of reading field height with read distance and resolution

Line scanner with oscillating mirror (lateral reading window): BCL 90 CAT OM100/OM 100 H

Resolution: 0.35 mm

Opening angle: 40°

Read distance [mm]

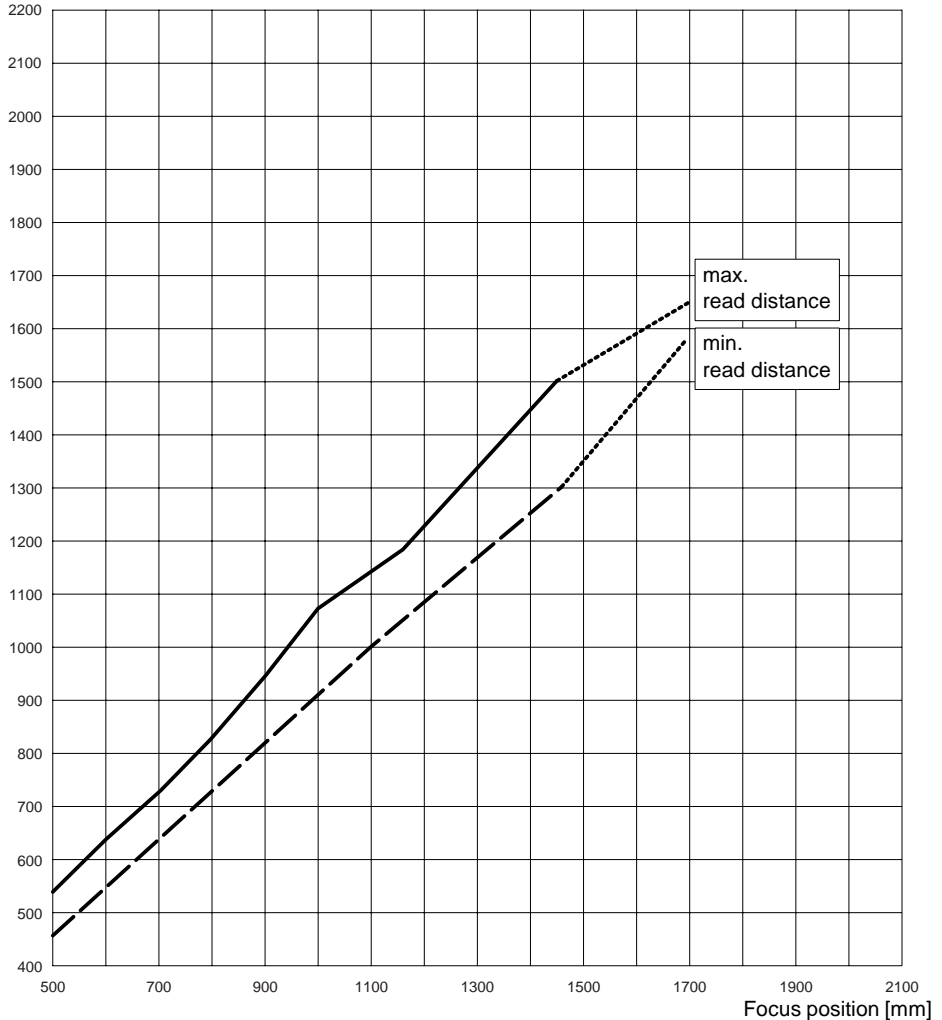

Characteristics of scanning frequency variation with read distance and resolution:
see Figure 4.14

Reading conditions:
see Table 4.5

Figure 4.10: BCL 90 CAT OM 100/OM 100 H (medium density): variation of min. and max. read distance (radially measured) with focus position at 0.35 mm resolution and opening angle $\alpha = 40^\circ$

Line scanner with oscillating mirror (lateral reading window): BCL 90 CAT OM100/OM 100 H

Resolution: **0.35** mm

Opening angle: **50°**

Read distance [mm]

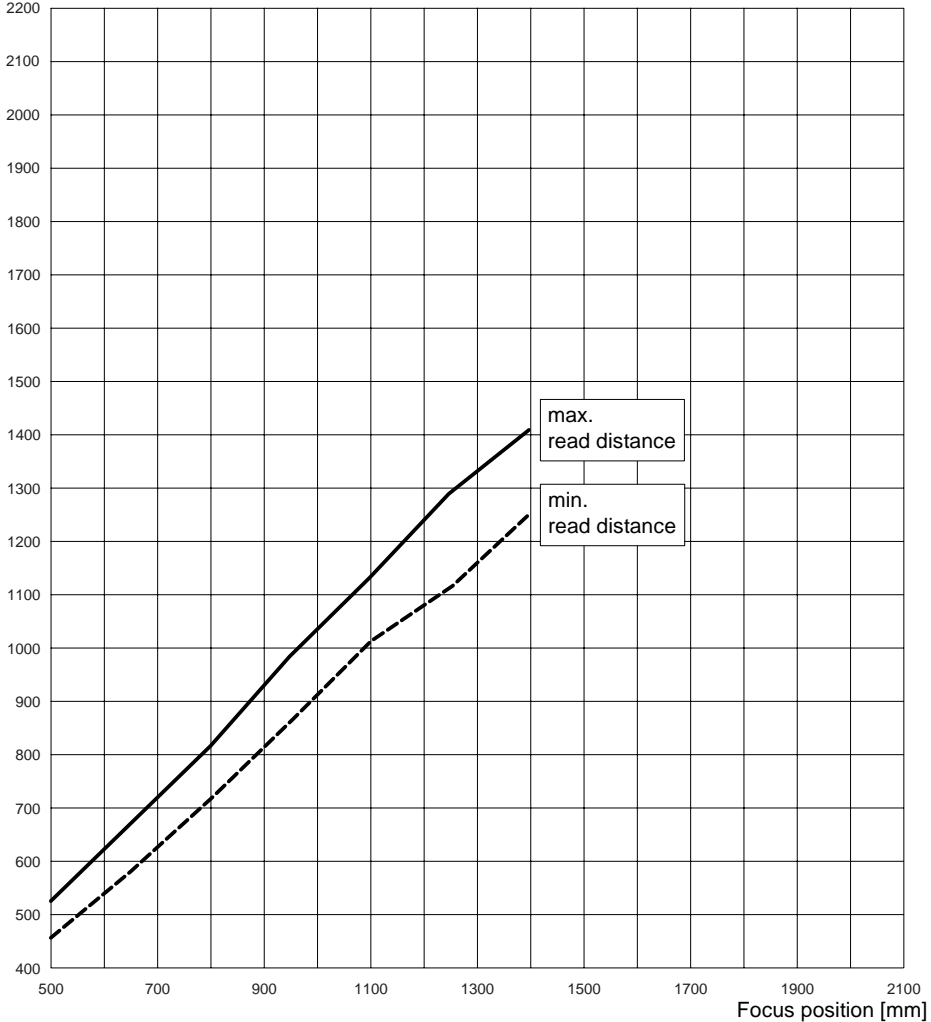

Characteristics of scanning frequency variation with read distance and resolution:

see Figure 4.14

Reading conditions:
see Table 4.5

Figure 4.11: BCL 90 CAT OM 100/OM 100 H (medium density): variation of min. and max. read distance (radially measured) with focus position at 0.35 mm resolution and opening angle $\alpha = 50^\circ$

Line scanner with oscillating mirror (lateral reading window): BCL 90 CAT OM100/OM 100 H

Resolution: 0.50 mm

Opening angle: 40°

Read distance [mm]

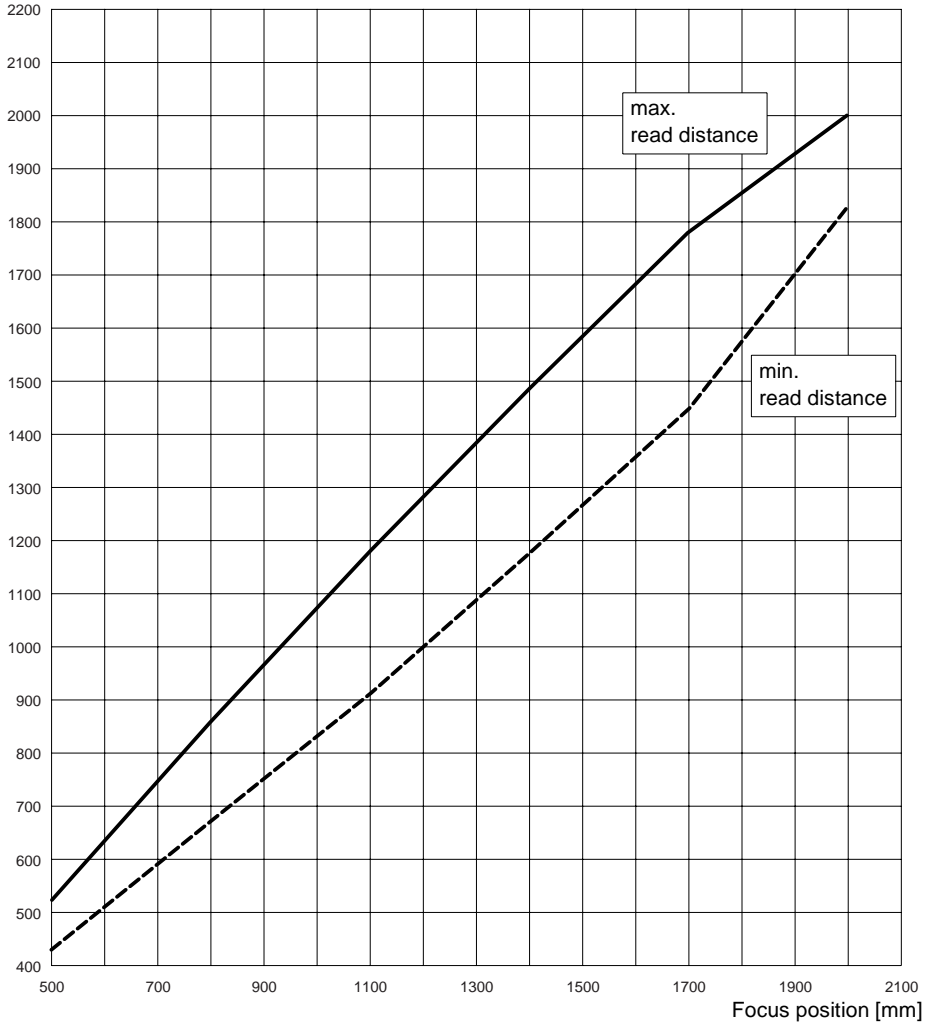

Characteristics of scanning frequency variation with read distance and resolution:
see Figure 4.14

Reading conditions:
see Table 4.5

Figure 4.12: BCL 90 CAT OM 100/OM 100 H (medium density): variation of min. and max. read distance (radially measured) with focus position at 0.50 mm resolution and opening angle $\alpha = 40^\circ$

Line scanner with oscillating mirror (lateral reading window): BCL 90 CAT OM100/OM 100 H

Resolution: **0.50** mm

Opening angle: **50°**

Read distance [mm]

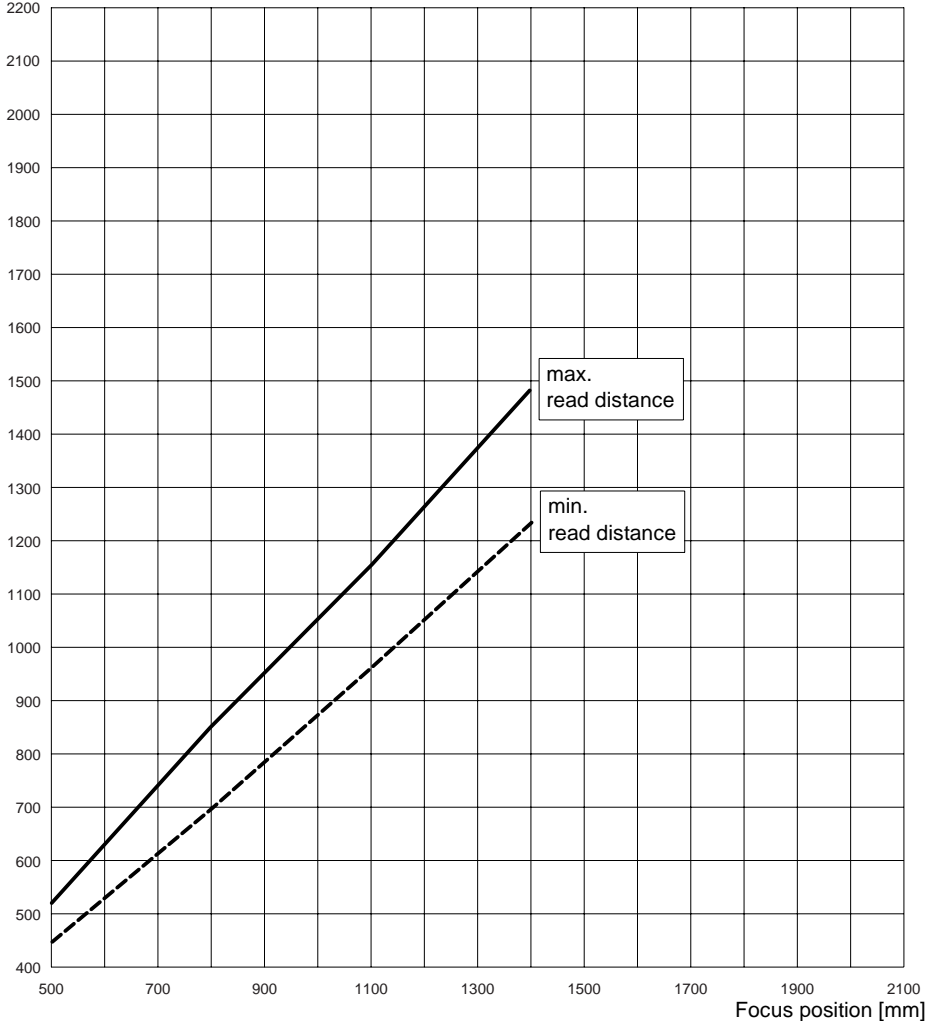

Characteristics of scanning frequency variation with read distance and resolution:

see Figure 4.14

Reading conditions:
see Table 4.5

Figure 4.13: BCL 90 CAT OM 100/OM 100 H (medium density): variation of min. and max. read distance (radially measured) with focus position at 0.50 mm resolution and opening angle $\alpha = 50^\circ$

Line scanner with oscillating mirror (lateral reading window): BCL 90 CAT OM100/OM 100 H

Scanning frequency [Hz]

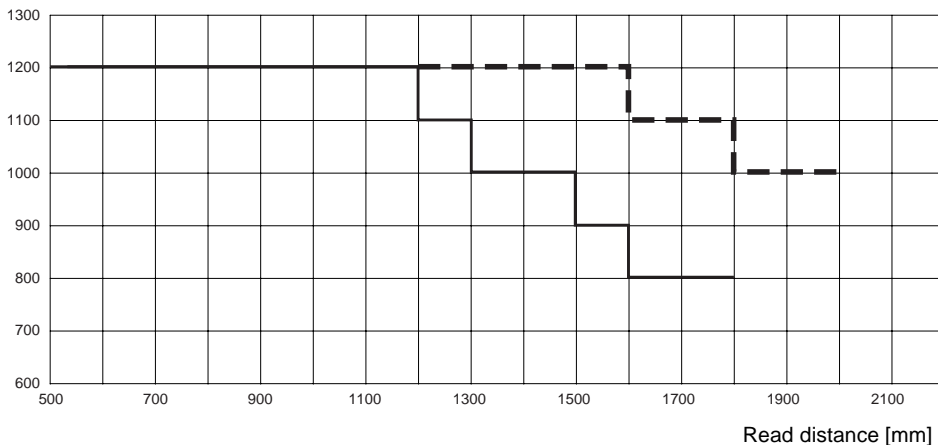

Resolution:
 ——— 0.35 mm
 - - - - 0.50 mm

Reading conditions:
 see Table 4.5

Figure 4.14: BCL 90 CAT OM 100/OM 100 H (medium density): characteristics of scanning frequency variation with read distance and resolution

Line scanner with oscillating mirror (lateral reading window): BCL 90 CAT OM100/OM100 H

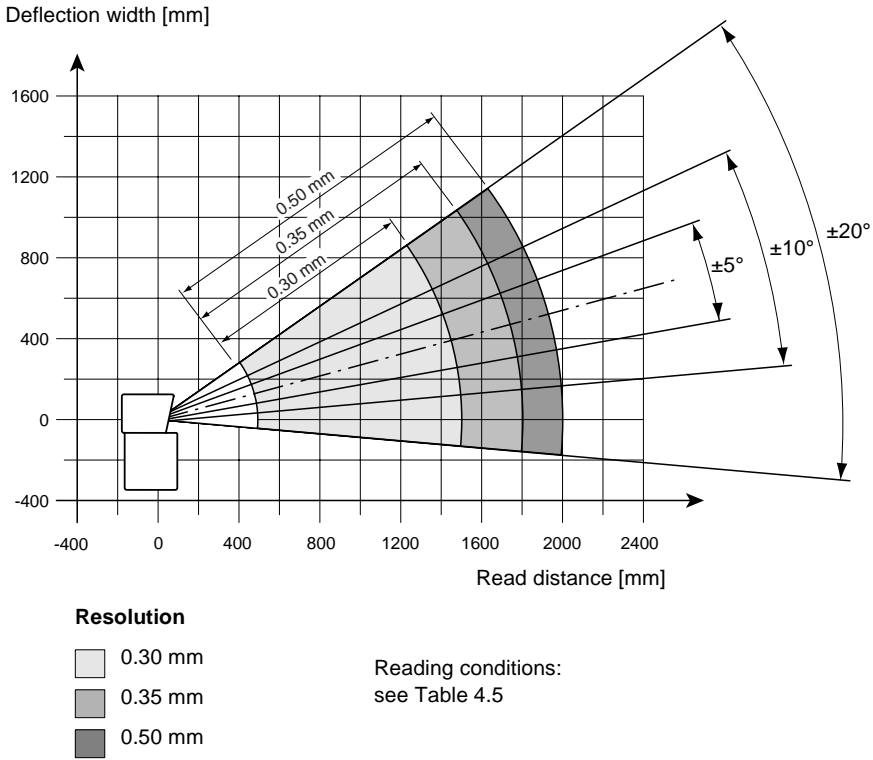

Figure 4.15: BCL 90 CAT OM100/OM100H: variation of deflection width with read distance, deflection angle and resolution

4.3.5 High Density: Reading Performance Data of Line Scanner

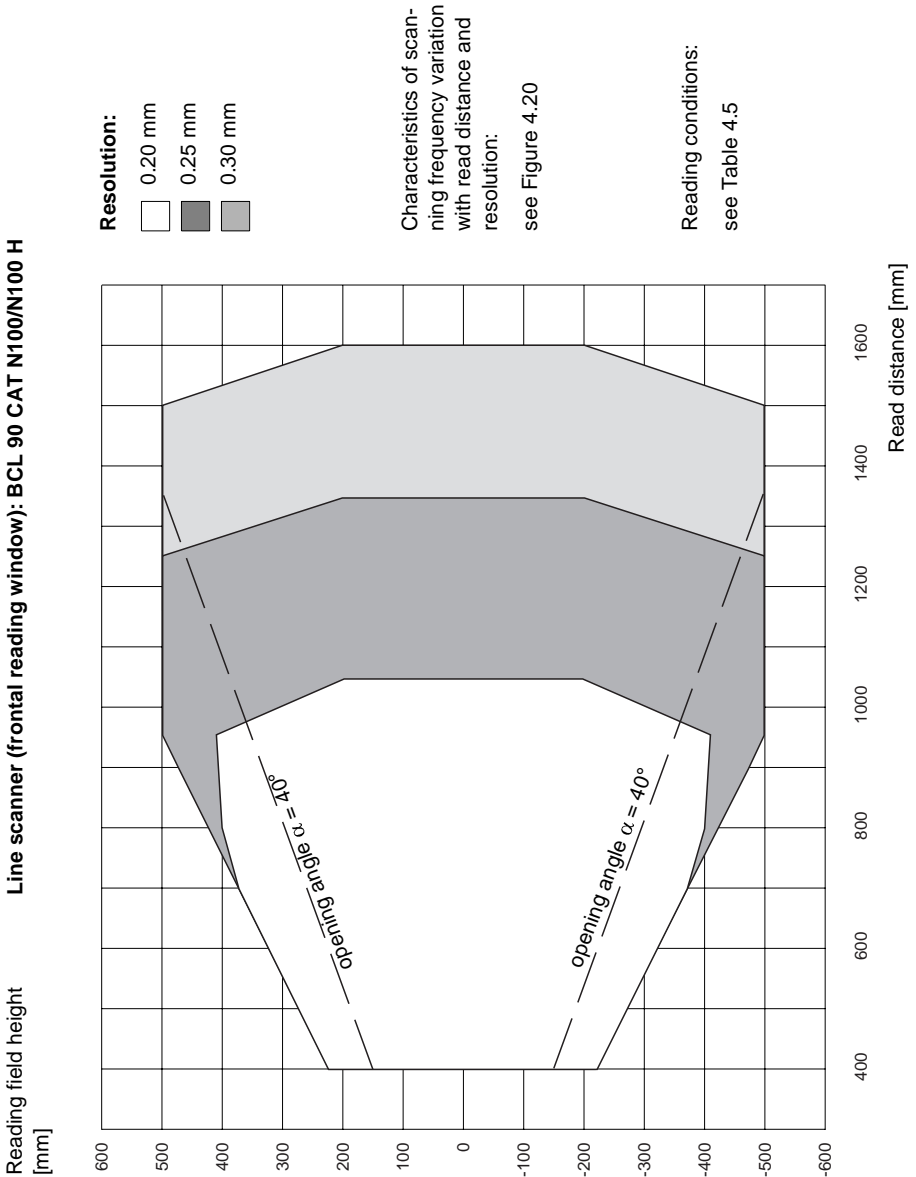
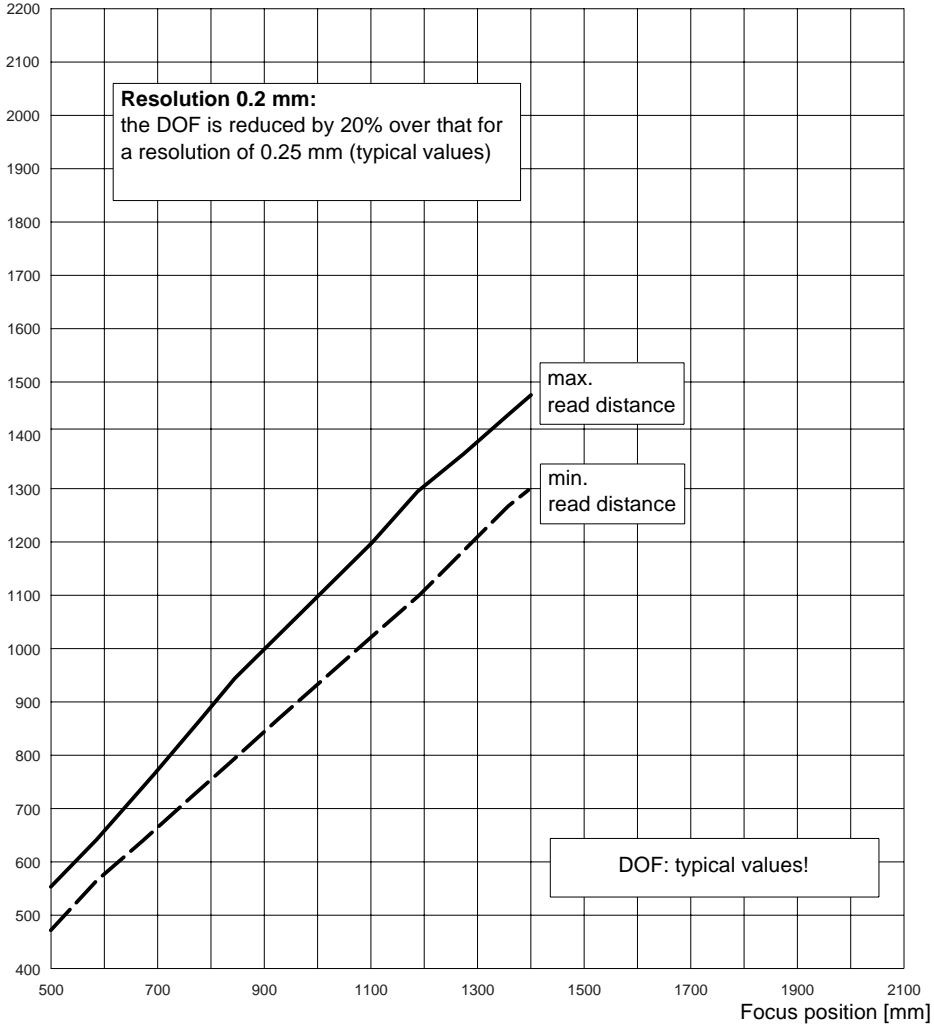

Figure 4.16: BCL 90 CAT N100/N100 H (high density): variation of reading field height with read distance and resolution

Line scanner (frontal reading window): BCL 90 CAT N 100/N 100 H

Resolution: **0.25 mm**
Opening angle: **40°**

Read distance [mm]



Characteristics of scanning frequency variation with read distance and resolution:
see Figure 4.20

Reading conditions:
see Table 4.5

Figure 4.17: BCL 90 CAT N100/N100H (high density): variation of min. and max. read distance (radially measured) with focus position at 0.25 mm resolution and opening angle $\alpha = 40^\circ$

Line scanner (frontal reading window): BCL 90 CAT N 100/N 100 H

Resolution: 0.35 mm

Opening angle: 40°

Read distance [mm]

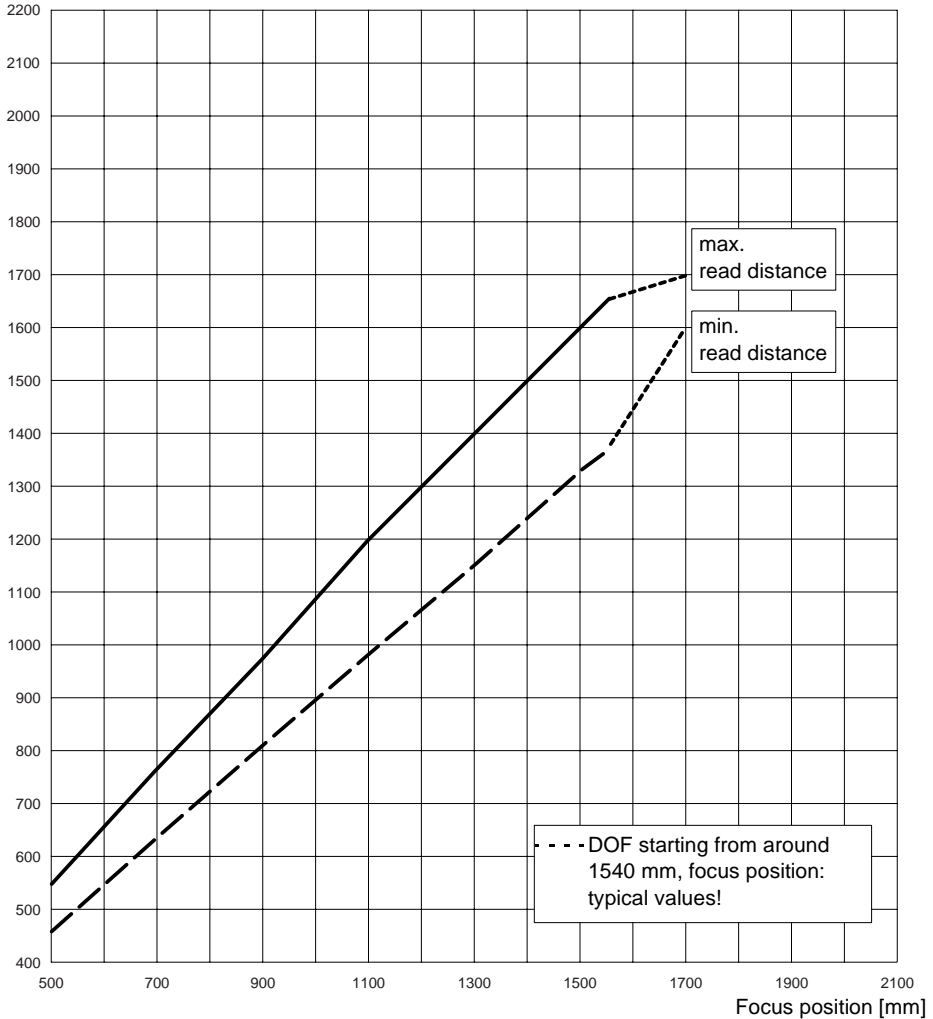

Characteristics of scanning frequency variation with read distance and resolution:
see Figure 4.20

Reading conditions:
see Table 4.5

Figure 4.18: BCL 90 CAT N 100/N 100 H (high density): variation of min. and max. read distance (radially measured) with focus position at 0.35 mm resolution and opening angle $\alpha = 40^\circ$

Line scanner (frontal reading window): BCL 90 CAT N 100/N 100 H

Resolution: **0.35** mm

Opening angle: **56°**

Read distance [mm]

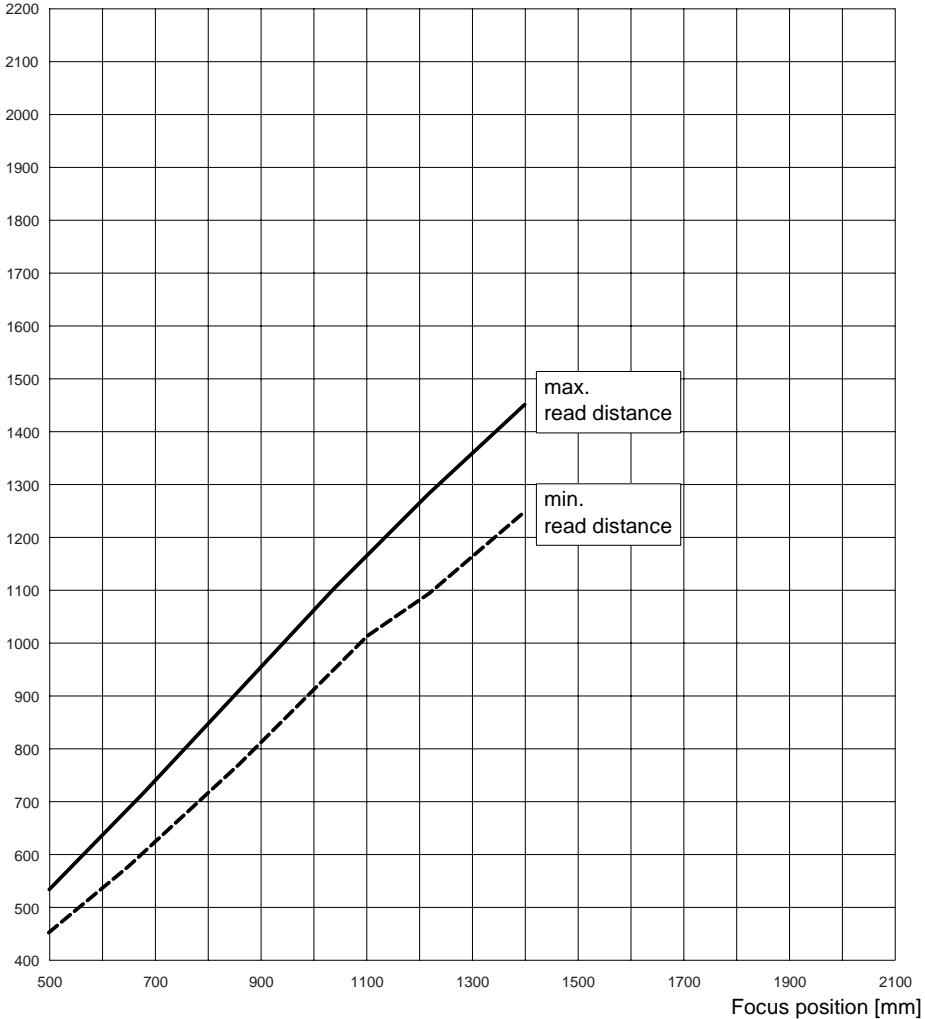

Characteristics of scanning frequency variation with read distance and resolution:
see Figure 4.20

Reading conditions:
see Table 4.5

Figure 4.19: BCL 90 CAT N 100/N 100 H (high density): variation of min. and max. read distance (radially measured) with focus position at 0.35 mm resolution and opening angle $\alpha = 56^\circ$

Line scanner (frontal reading window): BCL 90 CAT N 100/N 100 H

Scanning frequency [Hz]

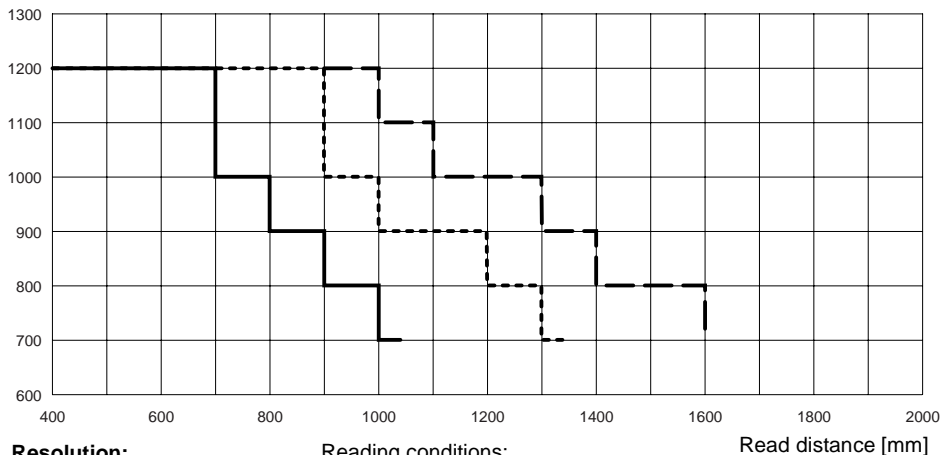

Resolution:
 ——— 0.20 mm
 - - - - 0.25 mm
 - · - · 0.30 mm

Reading conditions:
 see Table 4.5

Read distance [mm]

Figure 4.20: BCL 90 CAT N 100/N 100 H (high density): characteristics of scanning frequency variation with read distance and resolution

4.3.6 High-Density: Reading Performance Data of Line Scanner with Oscillating Mirror

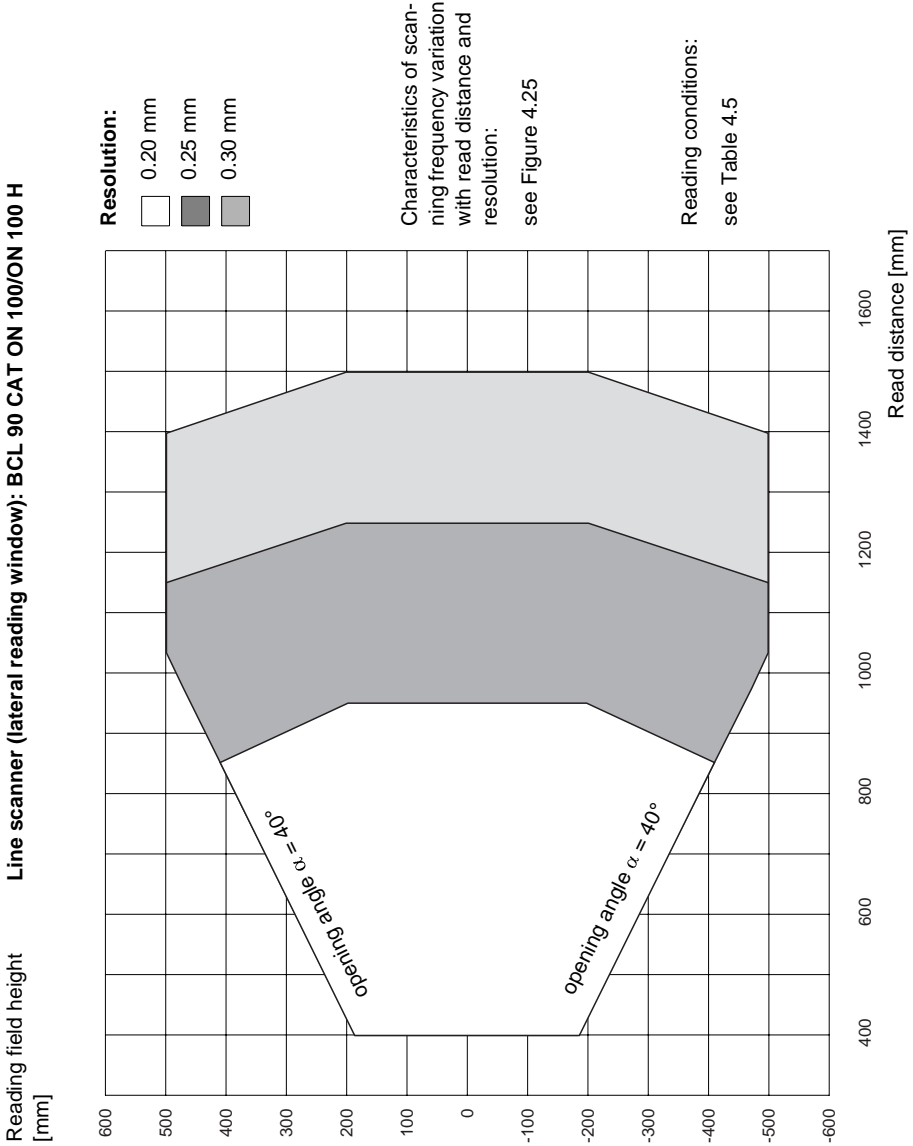

Figure 4.21: BCL 90 CAT ON 100/ON 100 H (high density): variation of reading field height with read distance and resolution

Line scanner with oscillating mirror (lateral reading window): BCL 90 CAT ON 100/ON 100 H

Resolution: 0.25 mm

Opening angle: 40°

Read distance [mm]

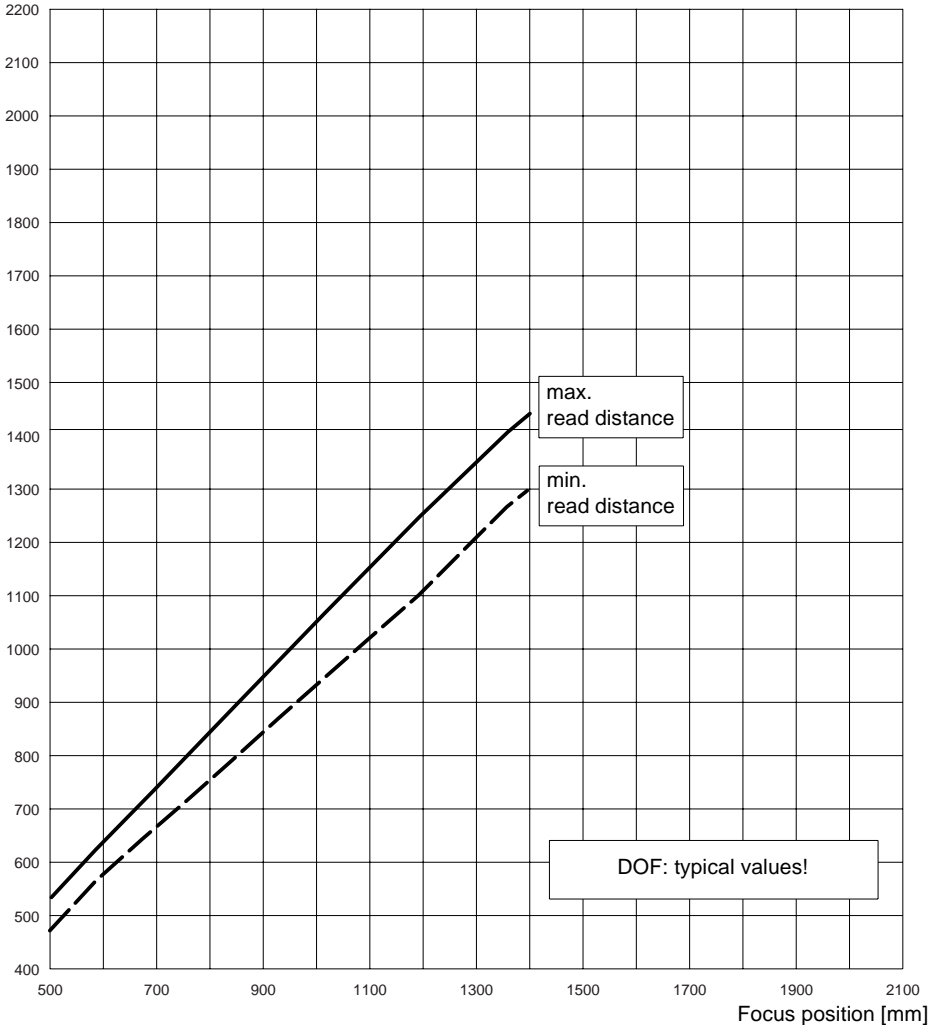

Characteristics of scanning frequency variation with read distance and resolution:
see Figure 4.25

Reading conditions:
see Table 4.5

Figure 4.22: BCL 90 CAT ON 100/ON 100 H (high density): variation of min. and max. read distance (radially measured) with focus position at 0.25 mm resolution and opening angle $\alpha = 40^\circ$

Line scanner with oscillating mirror (lateral reading window): BCL 90 CAT ON 100/ON 100 H

Resolution: **0.35 mm**

Opening angle: **40°**

Read distance [mm]

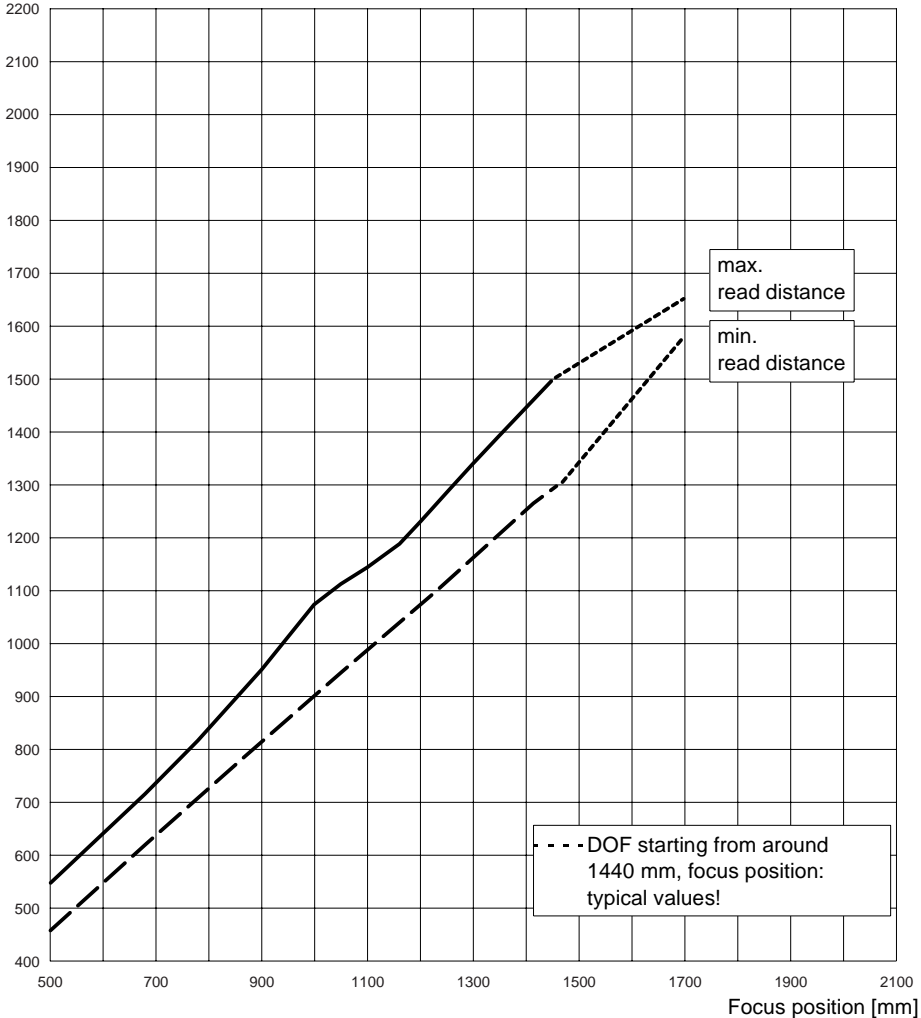

Characteristics of scanning frequency variation with read distance and resolution:
see Figure 4.25

Reading conditions:
see Table 4.5

Figure 4.23: BCL 90 CAT ON 100/ON 100 H (high density): variation of min. and max. read distance (radially measured) with focus position at 0.35 mm resolution and opening angle $\alpha = 40^\circ$

Line scanner with oscillating mirror (lateral reading window): BCL 90 CAT ON 100/ON 100 H

Resolution: 0.35 mm

Opening angle: 50°

Read distance [mm]

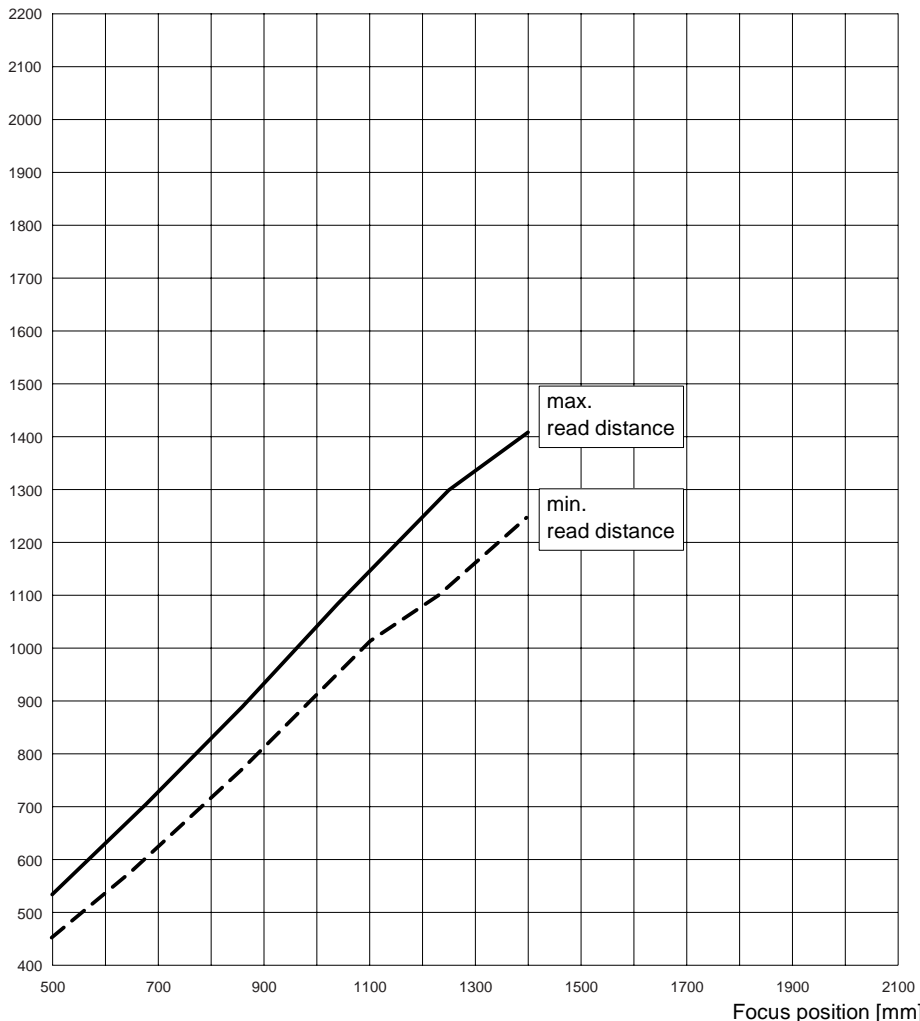

Characteristics of scanning frequency variation with read distance and resolution:
see Figure 4.25

Reading conditions:
see Table 4.5

Figure 4.24: BCL 90 CAT ON 100/ON 100 H (high density): variation of min. and max. read distance (radially measured) with focus position at 0.35 mm resolution and opening angle $\alpha = 50^\circ$

Line scanner with oscillating mirror (lateral reading window): BCL 90 CAT ON 100/ON 100 H

Scanning frequency [Hz]

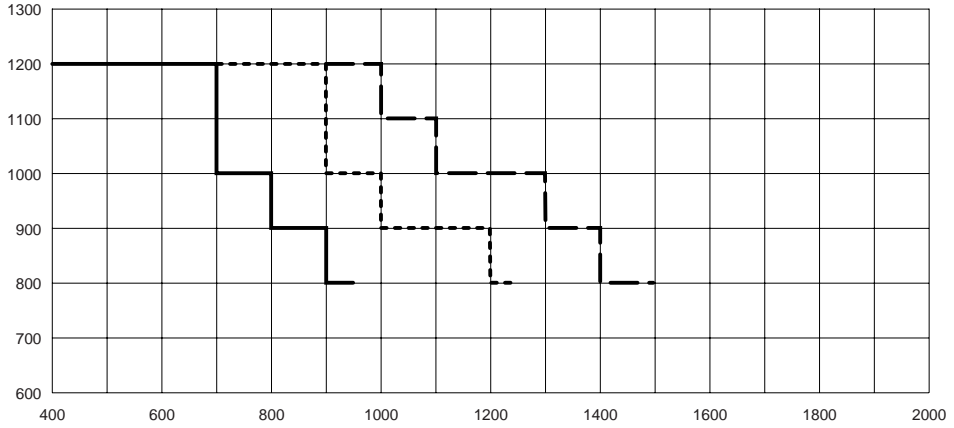

Resolution:

- 0.20 mm
- - - 0.25 mm
- 0.30 mm

Reading conditions:
see Table 4.5

Read distance [mm]

Figure 4.25: BCL 90 CAT ON 100/ON 100 H (high density): characteristics of scanning frequency variation with read distance and resolution

Line scanner with oscillating mirror (lateral reading window): BCL 90 CAT ON 100/ON 100 H

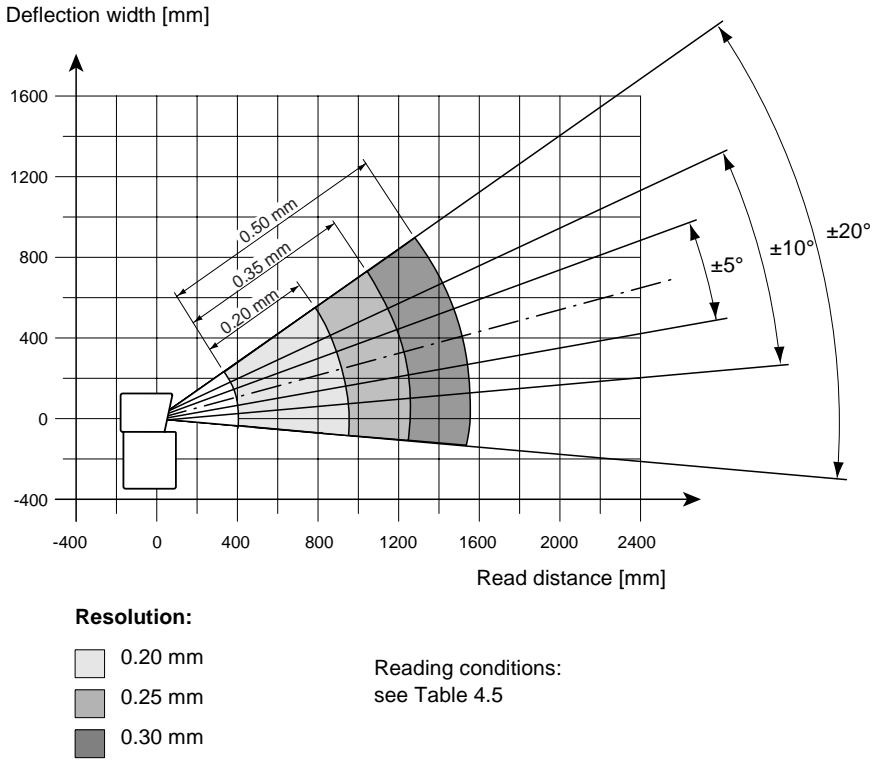

Figure 4.26: BCL 90 CAT ON 100/ON 100 H: variation of deflection width with read distance, deflection angle and resolution

4.3.7 Low Density: Reading Performance Data of Line Scanner

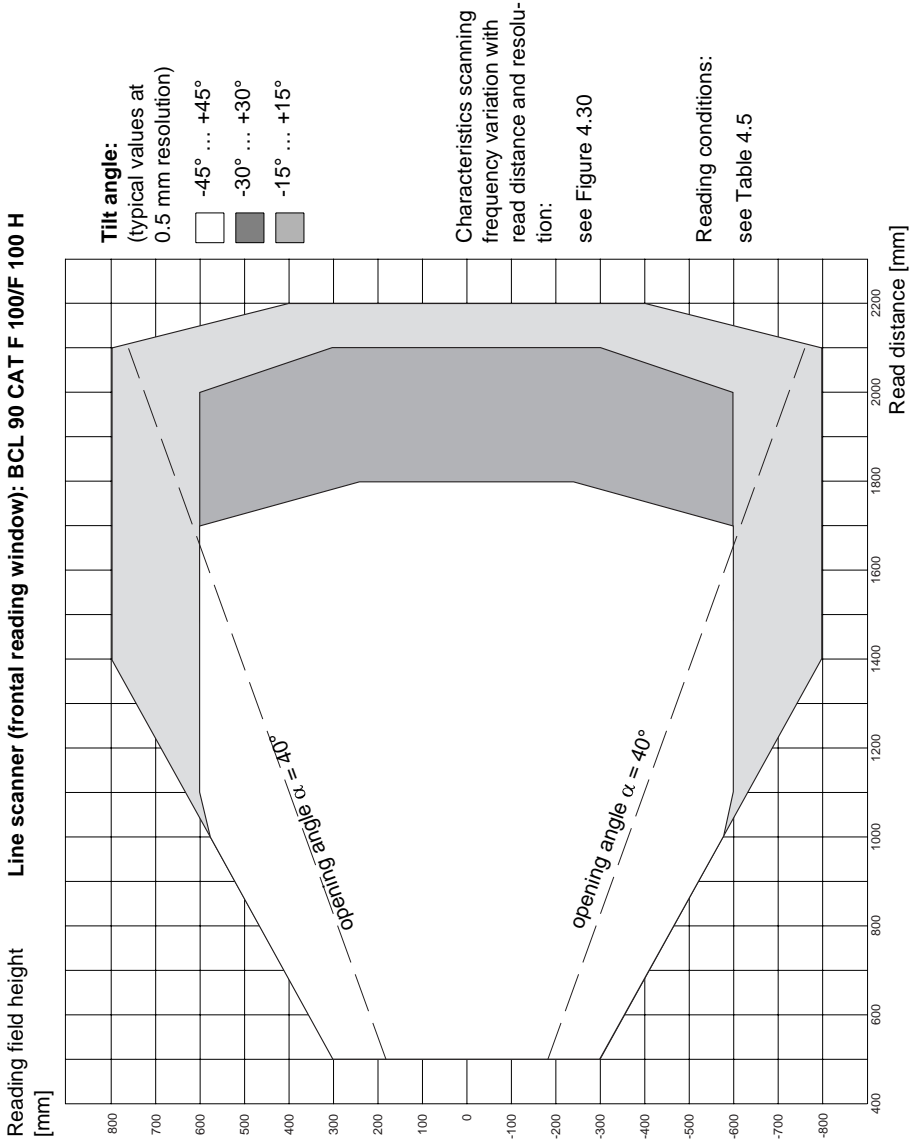

Figure 4.27: BCL 90 CAT F 100/F 100 H (low density): variation of reading field height with read distance and tilt at 0.5 mm resolution

Line scanner (frontal reading window): BCL 90 CAT F 100/F 100 H

Resolution: 0.50 mm

Opening angle: 40°

Read distance [mm]

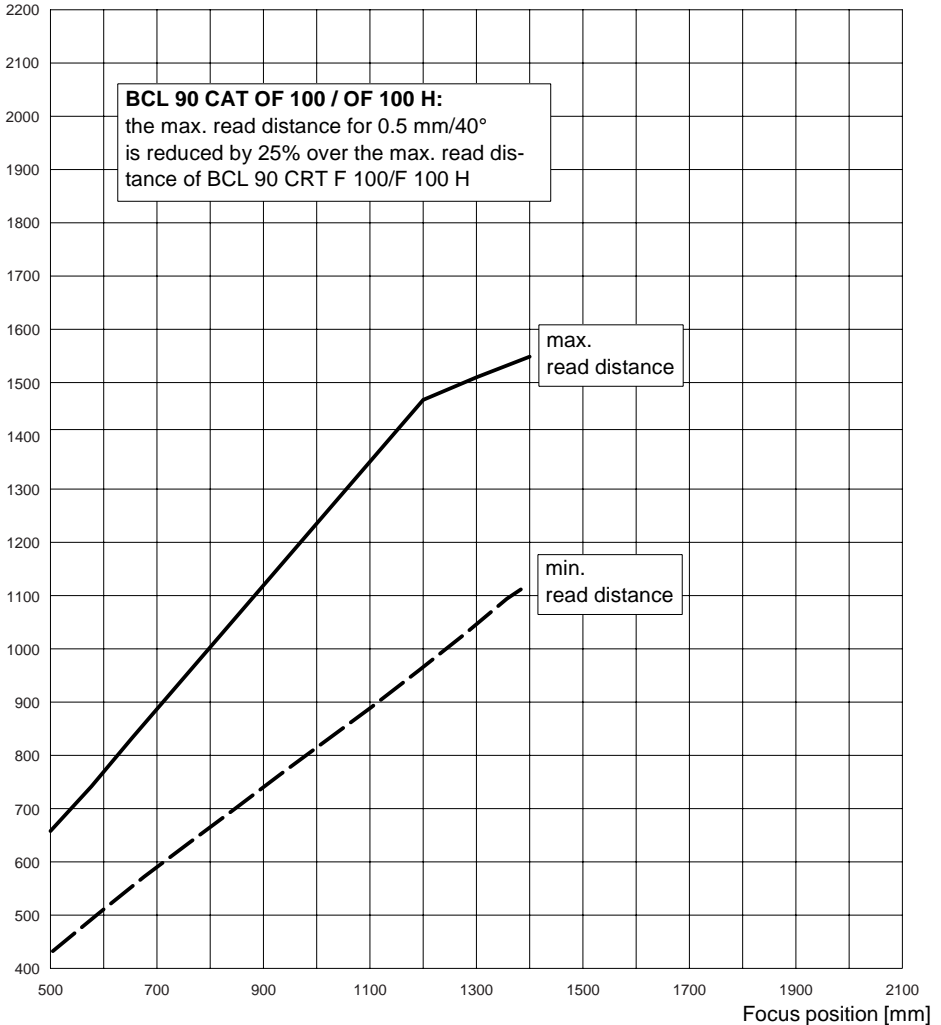

Characteristics of scanning frequency variation with read distance and resolution:
see Figure 4.30

Reading conditions:
see Table 4.5

Figure 4.28: BCL 90 CAT F 100/F 100 H (low density): variation of min. and max. read distance (radially measured) with focus position at 0.50 mm resolution and opening angle $\alpha = 40^\circ$

Line scanner (frontal reading window): BCL 90 CAT F 100/F 100 H

Resolution: **0.50** mm

Opening angle: **60°**

Read distance [mm]

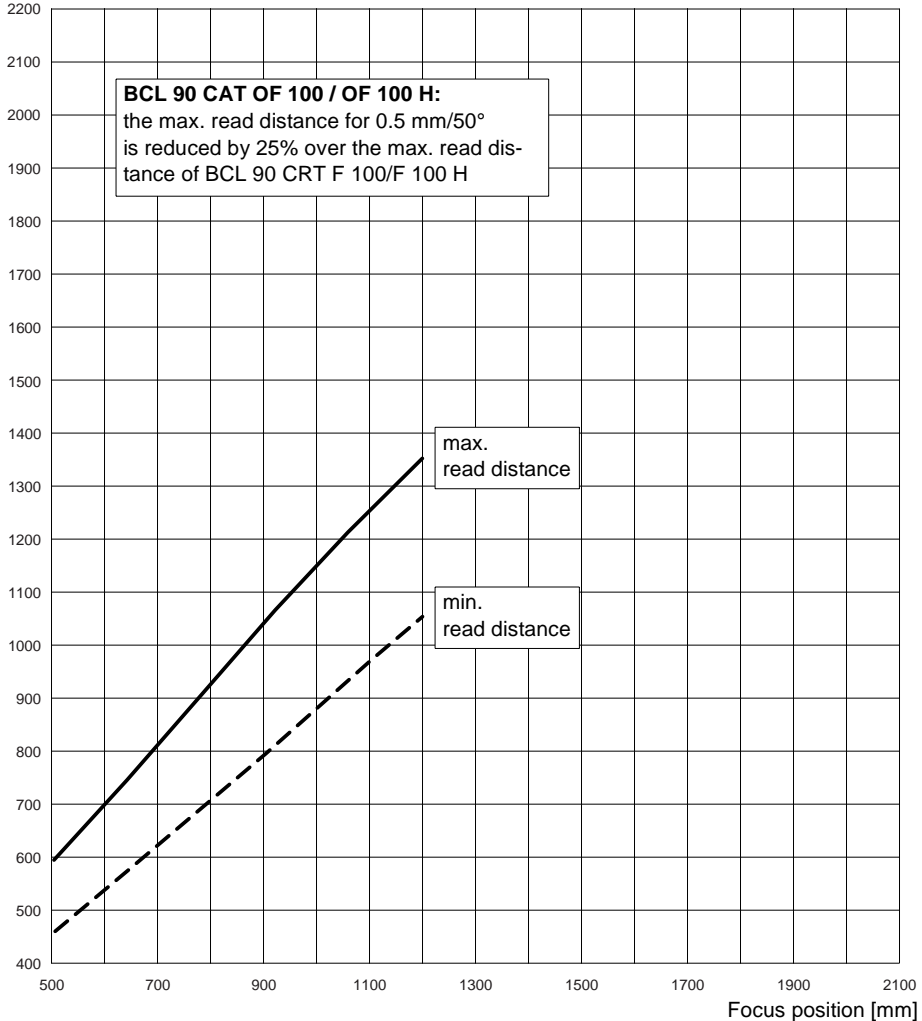

Characteristics of scanning frequency variation with read distance and resolution:
see Figure 4.30

Reading conditions:
see Table 4.5

Figure 4.29: BCL 90 CAT F 100/F 100 H (low density): variation of min. and max. read distance (radially measured) with focus position at 0.50 mm resolution and opening angle $\alpha = 60^\circ$

Line scanner (frontal reading window): BCL 90 CAT F 100/F 100 H

Scanning frequency

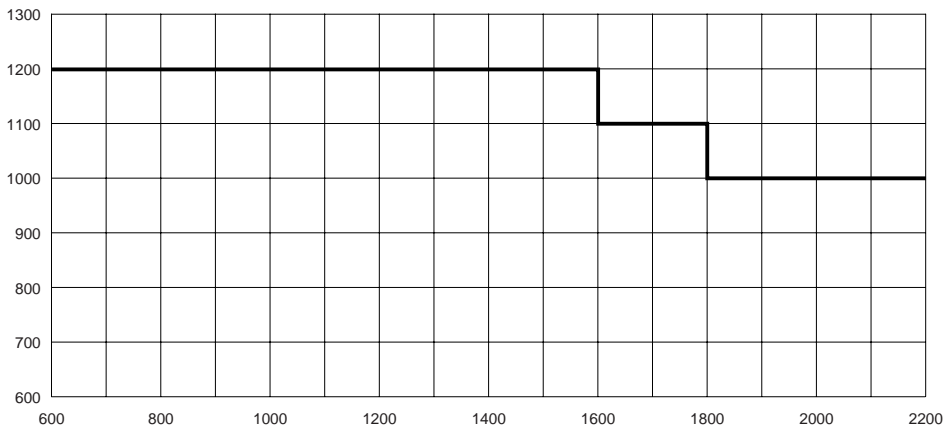

Resolution:
 ——— 0.50 mm

Reading conditions:
 see Table 4.5

Read distance [mm]

Figure 4.30: BCL 90 CAT F 100/F 100 H (low density): characteristics of scanning frequency variation with read distance and resolution

4.3.8 Low Density: Reading Performance Data of Line Scanner with Oscillating Mirror

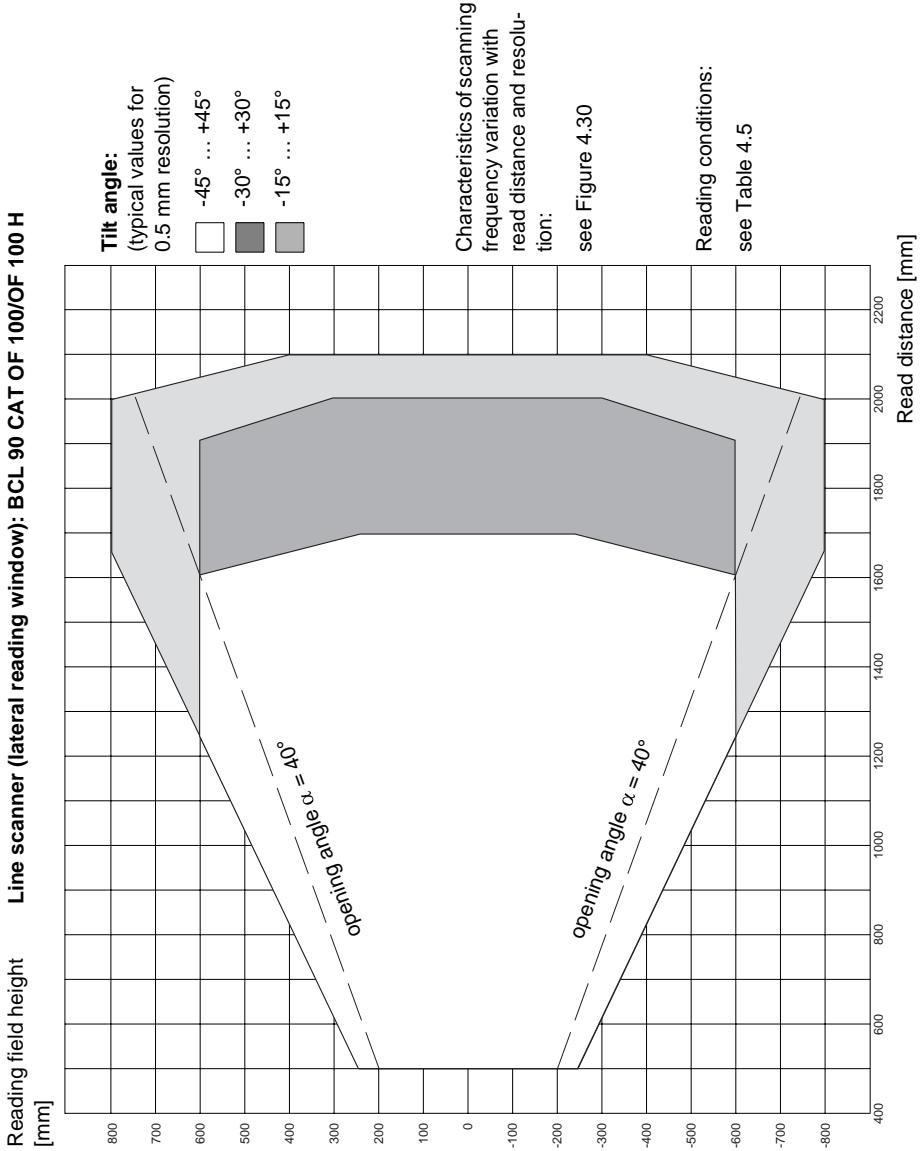

Figure 4.31: BCL 90 CAT OF 100/OF 100 H (low density): variation of reading field height with read distance and tilt at 0.5 mm resolution

Read distances for 0.5 mm resolution / opening angle 40°:
 see Figure 4.28, on page 59

Read distances for 0.5 mm resolution / opening angle 40°:
 see Figure 4.29, on page 60

Line scanner with oscillating mirror (lateral reading window): BCL 90 CAT OF 100/OF 100 H

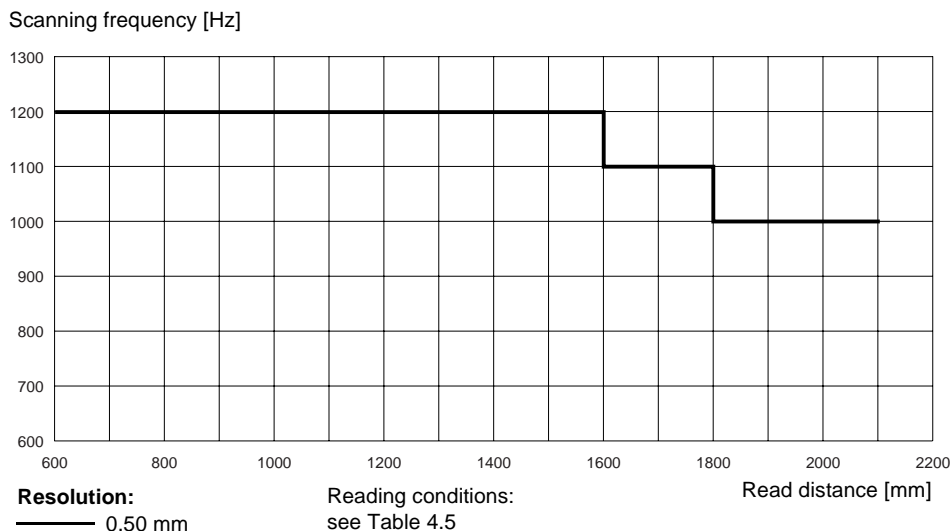
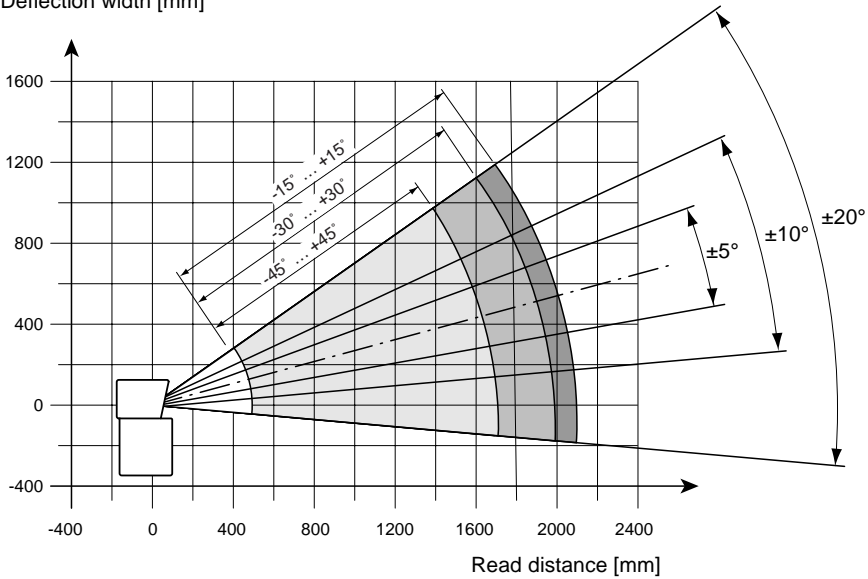





Figure 4.32: BCL 90 CAT OF 100/OF 100 H (low density): characteristics of scanning frequency variation with read distance and resolution

Line scanner with oscillating mirror (lateral reading window): BCL 90 CAT OF 100/OF 100 H

Deflection width [mm]



Tilt:	Resolution:
 $-45^\circ \dots +45^\circ$	0.50 mm
 $-30^\circ \dots +30^\circ$	
 $-15^\circ \dots +15^\circ$	

Reading conditions:
see Table 4.5

Figure 4.33: BCL 90 CAT OF 100/OF 100 H (low density): variation of deflection width with read distance, deflection angle and tilt at 0.50 mm resolution

5 Accessories (Order Codes)

5.1 Device and Connection Accessories

5.1.1 External Parameter Memory

The external parameter memory is an optional supplement to the BCL. It is located in a plug cover and consists of a permanent, rewritable memory (EEPROM). After being mounted, the two connections of the BCL are under the plug cover in a common protection class IP 65. Figure 5.1 is a view of the plug cover. Two pre-assembled connection cables that are permanently connected to the plug cover by PG screw glands provide the BCL with unaltered signals.

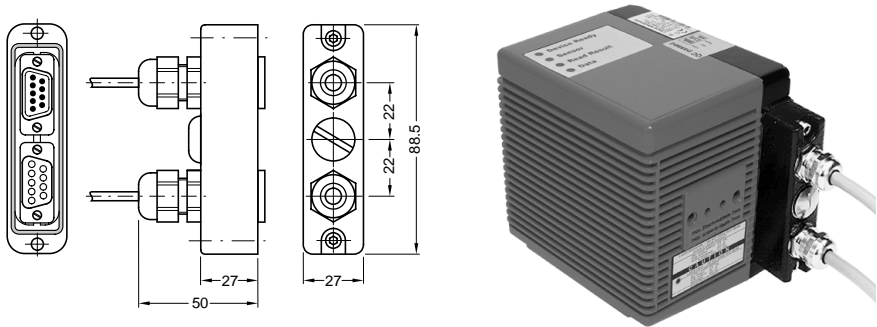

Figure 5.1: View of the external parameter memory, mounted on the BCL

The external parameter memory can only be operated with a BCL **without** heater. Various types are available:

Type / order number	Connection cables with	Length	Connecting
KB 090-3000P / 500 35 322	two 15-pin D-Sub-HD plug connections (Pin assignment 1:1 to the BCL device connections)	3 m	BCL to MA 90
KB 090-3000PO / 500 35 323	two open cable ends	3 m	BCL to external power supply unit, open wiring

Table 5.1: Types of external parameter memories

Function

When started, the BCL initialises itself with data stored in its internal parameter set. When a clone of this parameter set is also kept ready at hand in an external memory, devices can be exchanged quickly. The replacement device does not need to be manually configured first before operation, but automatically accesses the external parameter memory by selecting the start option accordingly. It downloads the parameter set stored in the parameter memory into its operating memory (RAM).



Reading cycle generation!

The Leuze catalogue contains a large selection of light barriers and switches as well as accessories (mounting supports, connection cables).

5.1.2 Cables, External Parameter Memories and Plug Covers

BCL without heater

Temperature range of the connection materials:

Stationary: -30 ... +70°C; moving: 0 ... +70°C

Type / order number	Description	Cores	Length	Connecting
KB 090-3000 / 500 35 319	Connecting cable for data interfaces ("host/term") or function interfaces ("I/O"), Ø 8 mm, shielded, with 15-pin D-Sub-HD cable socket and 15-pin D-Sub-HD cable plug. Required quantity: 2 per BCL	15	3 m	BCL 90 to MA 90
KB 090-3000B / 500 35 320	Connection cable for data interfaces ("host/term"), Ø 8 mm, shielded, with 15-pin D-Sub-HD cable socket and open end (stripped). Required quantity: 1 per BCL	15	3 m	BCL 90 to host
KB 090-3000S / 500 35 321	Connection cable for function interfaces and power supply ("I/O"), Ø 8 mm, shielded, with 15-pin D-Sub-HD cable plug and open end (stripped). Required quantity: 1 per BCL	15	3 m	BCL 90 to sensors, PLC and external power supply unit
KB 090-3000P / 500 35 322	Plug cover with parameter memory (EEPROM), protection class IP 65, with two connection cables, Ø 8 mm each, shielded, with 15-pin D-Sub-HD cable socket and 15-pin D-Sub-HD cable plug Required quantity: 1 per BCL	each 15 x 0.14 mm ²	3 m	BCL 90 to MA 90
KB 090-3000PO / 500 35 323	Plug cover with parameter memory (EEPROM), protection class IP 65, with two connection cables, Ø 8 mm each, shielded, two open ends (stripped). Required quantity: 1 per BCL	each 15 x 0.14 mm ²	3 m	BCL 90 to host, sensors, PLC and external power supply unit

Table 5.2: Available accessories: cables and plug covers for the BCL without heater



Notice!

Other cable lengths/cables for BCL without heater upon request.

b) BCL with heater

Temperature range of the connection materials:

Stationary: -50 ... +70 °C; moving: -40 ... +70 °C

Type / order number	Description	Cores	Length	Connecting
KB 090-3000H / 500 35 324	2 x plug covers, protection class IP 65, with two connecting cables, Ø 6.7 mm each, shielded. Required quantity: 1 per BCL	each 13 x 0.14 mm ² + 2 x 0.75 mm ²	3 m	BCL 90 to MA 90
KB 090-3000HO / 500 35 325	Plug cover, protection class IP 65, with two connection cables, Ø 6.7 mm each, shielded, two open ends (stripped). Required quantity: 1 per BCL	1 x 18 x 0.14 mm ² 1 x 2 x 0.75 mm ²	3 m	BCL 90 to host, sensors, PLC and external power supply unit

Table 5.3: Available accessories: cables and plug covers for the BCL with heater



Notice!

Other cable lengths/cables for BCL with heater upon request.

Leuze multiNet plus master

Order number	Type	Description
on request	MA 30 / MA 31	Network controller

Table 5.4: Available accessory component: network controller

5.2 Mounting Accessories

Type / order number	Description	Fig.
BT 90 S / 500 35 514	Quick-action clamping device, with complete fastening materials	Figure 5.4
BT 90 W / 500 35 515	Bracket support, single, with two screws M 6 x 10 mm, self-locking	Figure 5.2
BT 90 G / 500 35 516	Joint bracket (double bracket support 2 013 824), with 2 screws M 6 x 10 mm, self-locking	Figure 5.3

Table 5.5: Available accessories: mounting accessories

5.2.1 Dimensions

Bracket support BT 90 W, single No. 500 35 515

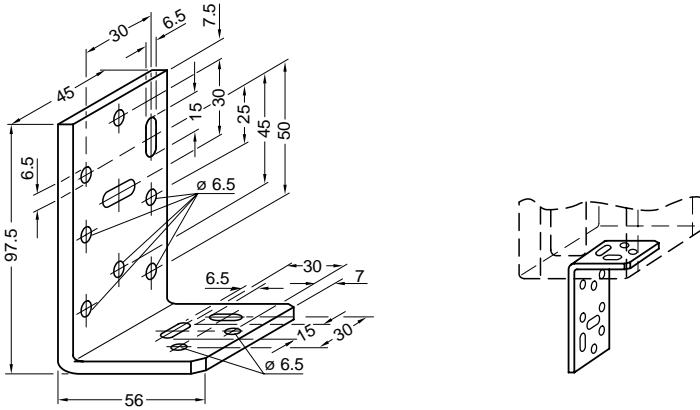

Figure 5.2: Dimensions of the bracket support, single

Joint bracket BT 90 G, No. 500 35 516

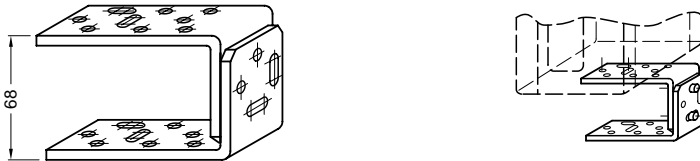

Figure 5.3: Dimensions of the joint bracket

View of the quick-action clamping device BT 90 S, No. 500 35 514

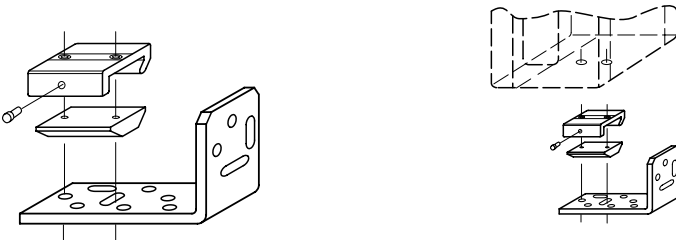

Figure 5.4: View of the quick-action clamping device with bracket support

6 Mounting

6.1 Overview of the Mounting Steps

- if needed, exchange the language version of the laser warning sign
- select mounting site for the BCL
- adjust the position of the BCL to the bar code
- mount the BCL
- modular connector unit MA 90
- connect the BCL to MA 90
- adjust the BCL
- mount the reading cycle sensor for external reading cycle triggering
- optional for event-driven focus position switching:
mount the sensors for external detection of the object distance

6.2 Preparing the Mounting

6.2.1 Have Ready the Components to be Mounted

- barcode scanner BCL

6.2.2 Have Ready Accessories

- Leuze mounting support for the BCL:
depending on order, bracket support No. 500 35 515, joint bracket No. 500 35 516 or quick-action clamping device No. 500 35 514 with fastening materials for the BCL

- or -

alternatively, in case the user provides the mounting support:

- sturdy mounting device enabling the BCL to change its orientation on the x-axis and y-axis. The line scanner type BCL weighs 1.5 kg , the line scanner with oscillating mirror type 2.2 kg
- two M6 screws for the BCL. Screw length depends on the wall thickness of the mounting support used. Reach of the screw in the **BCL max. 7 mm** measured from housing surface
- modular connector unit MA 90 (not included in the scope of delivery of the BCL)
- reading cycle sensor, e.g. retro-reflective photo electric sensor/light switch (not included in the scope of delivery of the BCL)
- optional for event-driven focus position switching: sensors for the detection of the read distance, e.g. retro-reflective photo electric sensor/light switch (not included in the scope of delivery of the BCL)

6.2.3 Lay Aside Auxiliary Materials

- two M6 screws to fasten the Leuze mounting support to the mounting base. Screw length depends on the wall thickness of the mounting base
- one set of laser warning signs (as required)
- tools
- measuring tape (up to 3000 mm)
- L-blade

6.2.4 Exchanging the Laser Warning Sign

If required, paste over the British/American English laser warning sign attached to the BCL with a warning sign in the actual language (Figure 6.1).

The included set of laser warning signs consists of:

- a German/American English warning sign
- a French/American English warning sign

Also see Section 2.3, on page 13.

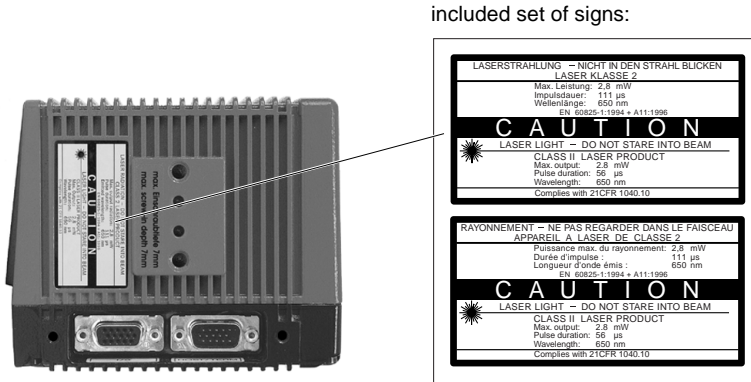

Figure 6.1: Line scanner as example: exchanging the laser warning sign

6.2.5 Selecting the Mounting Site

In selecting the mounting site, the distance between the BCL and host as well as the distance between the BCL and the bar code have to be taken into consideration.

Distance between the BCL and host

If it is not connected to the Leuze network or a bus connection, the BCL can be mounted at a distance of max. 1200 m from the host. The actual distance, however, depends on the selected physical type of the host interface and the adjusted data transmission rate.

See table 7.6 on page 83

Distance between the BCL and MA 90

The MA 90 should not be mounted further than 10 m away from the BCL because the PC accesses the terminal interface of the BCL through the software BCL-Config via the module (RS 232 type).

6.2.6 Fastening Accessories

The BCL is attached by way of two fastening threads (M6) located above the electrical connections. Figure 6.2 shows the location of the threads.

The complete housing dimensions of the BCL are shown in Figure 4.1 and Figure 4.2 starting from page 30.

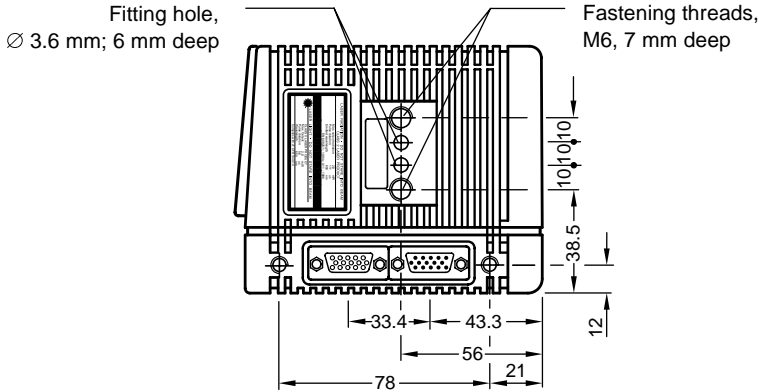

Figure 6.2: Line scanner as example: position of the fastening threads on the BCL

The BCL can be mounted using the following Leuze mounting supports:

- Bracket support BT 90 W, single No. 500 35 515
- Joint bracket (2 x single bracket supports) BT 90 G, No. 500 35 516
- Quick-action clamping device BT 90 S, No. 500 35 514

The mounting supports are designed in such a way that allows diverse mounting variations and the orientation of the BCL on two levels. Figure 6.3 shows two examples for mounting the device. The long holes in bracket support No. 500 35 515 and joint bracket No. 500 35 516 allow the BCL to rotate within an angle of $\pm 15^\circ$ for a fine adjustment.

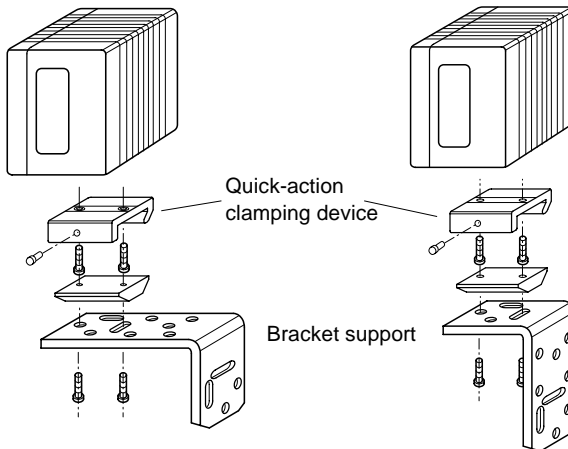

Figure 6.3: Example: possible ways to mount the bracket support BT 90 W (No. 500 35 515) in combination with the quick-action clamping device BT 90 S (No. 500 35 514)

The mounting support dimensions are shown in Section 5.2.1, on page 68

6.2.7 Distance between BCL and Bar Code

Principle Orientation of the Scan Line to the Bar Code

Depending on application, either the line scanner or line scanner with oscillating mirror version of the BCL is used. Figure 6.4 represents the principle orientation of the BCL based on the two scanning processes to the bar code on the object.

Line scanner

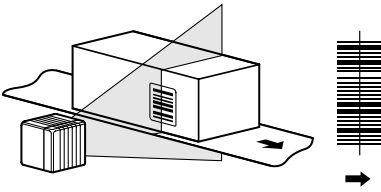

Line scanner with oscillating mirror

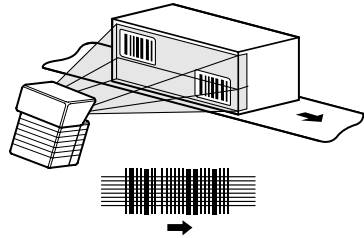

Figure 6.4: Orientation of the BCL based on the two scanning processes to bar code and direction of transport

Read distance to the bar code and opening angle α

The distance between the reading window of the BCL and the bar code may not exceed the technical limits specified for the device. Section Figure 4.3.; on page 34 and Section 4.3.4, on page 40 represent the variation of reading field height with read distance at various resolutions (module widths).

Figure 6.5 defines the read distance a from the reading window and the opening angle α for both scanning processes.

Line scanner

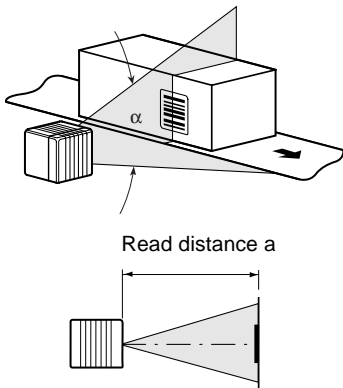

Line scanner with oscillating mirror

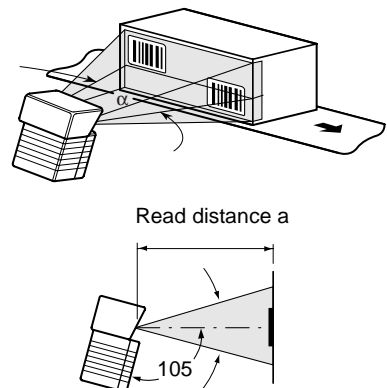

Figure 6.5: Definitions of read distance a and opening angle α

The line scanner's useful opening angle α is max. **56°** and that of the line scanner with oscillating mirror is max. **50°**. The reading field height (scan line length) depends on the read distance due to the V principle of beam deflection.

Angle adjustment of the BCL

The optimum alignment of the BCL is accomplished when the scan line scans the code bars almost at a right angle (90°) (Figure 6.4). All read angles that are possible between the scan line and bar code must be taken account of (Figure 6.6 and Table 6.1).

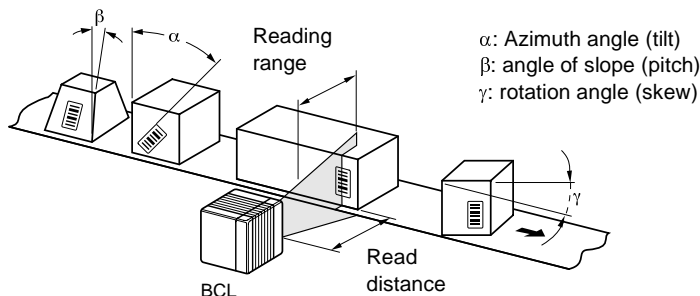

Figure 6.6: Line scanner: possible read angle between scan line and bar code

Angle	Limit value
Azimuth a (tilt)	max. 45°
Angle of slope b (pitch)	max. 45°
Rotation g (skew)	max. 45°

Table 6.1: Permissible read angle between scan line and bar code

Avoid surface reflections

If the light from the scan line hits the surface of the bar code at an exact right angle, the light scattered back and received may cause disturbing reflections. To avoid this effect, the BCL has to be mounted in such a way that the exiting light is tilted in relation to the vertical (Figure 6.7).

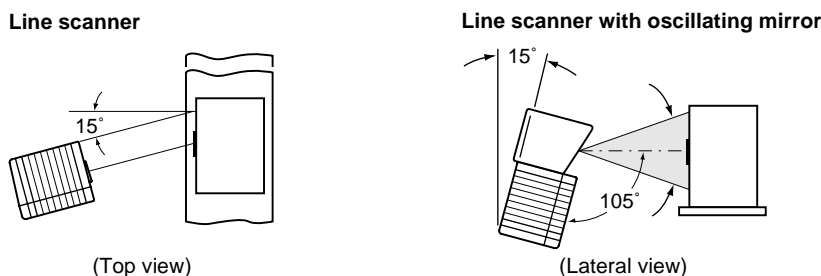

Figure 6.7: Avoiding surface reflections: angle between exiting light and bar code (tilt out of the vertical)

In line scanners with oscillating mirrors, the laser beam exits at an angle of 105° from the housing when passing through the zero position (CW=50) in oscillation operation. The device can only be mounted with its edge flush to the transport system when the amplitudes (deflection widths) are small. Otherwise, the device is also to be mounted at a slope of 15° to obtain symmetrical deflection ranges.



Notice!

In oscillation operation at variable amplitude, the scan line always has to pass over the zero position (CW=50). Therefore, oscillating in the range of e.g. 60 CW to 80 CW is not possible, but allowed in the range of e.g. 40 CW to 80 CW.

In oscillation operation at variable amplitude, the scan line always has to pass over the zero position (CW=50). Therefore, oscillating in the range of e.g. 60 CW to 80 CW is not possible, but allowed in the range of e.g. 40 CW to 80 CW.

6.2.8 Counting Direction of the Code Position CP and Code Angle CW

The BCL can scan and decode several bar codes in each reading. In this process, it determines for each bar code its read diagnosis data relating to its location:

- the position (CP value) of the bar code middle within the scan line
- additionally for scanning processes based on oscillating mirrors, the deflection angle of the scan line (CW value), within which the bar code middle is detected

Figure 6.8 shows the counting direction of the code position and code angle. In the line scanner, a small triangle above the reading window marks the counting direction of the code position.

By determining the two kinds of data, it is possible to separate the same bar codes (identical in respect to code type, code length and data content), and the BCL is able to correlate bar code data of the read result locally to bar code positions on the object.

Line scanner

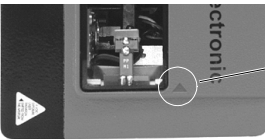
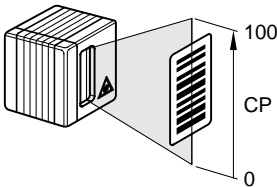

Mark:
counting direction
of the code position

Line scanner with oscillating mirror

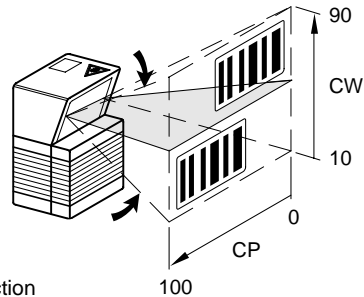

Opening angle α in the scanning direction: $1^\circ = 1.5 \text{ CP}$ ($56^\circ = 90 \text{ CP}$)

Deflection angle of the scan line across the scanning direction: $1^\circ = 2 \text{ CW}$ ($20^\circ = 40 \text{ CW}$)

Figure 6.8: Counting direction of the code position CP within the scan line and the code angle CW for oscillating mirror models



Notice!

In the base setting, the BCL does not output the values "CP" and "CW" in the read result of the host interface (only line scanner with oscillating mirror). Should this be requested for an evaluation in the host, the output can be activated in the separator of the output string via the user interface of BCL-Config.

6.3 Mounting and Adjusting the Device

6.3.1 Mounting the BCL

1. Prepare the mounting base for installing the mounting support of the BCL as described in Section 6.2.2, on page 69.
2. Place the object with bar code in the intended location in which the reading should take place, within the field of view of the BCL (no transport movement).
3. Orient the BCL to the bar code according to the scanning process and estimating by eyesight in such a way that
 - for line scanners, the back side of the device bearing the LED indicators is almost parallel to the bar code surface.
 - for line scanners with oscillating mirrors, the broad lateral wall (back side of the oscillating mirror) is almost parallel to the bar code surface.During the adjustment of the position, take account of all possible reading angles in subsequent readings (Figure 6.6).
4. In case this is relevant for an evaluation, you may have to take note of the counting direction of the code position and code angle (Figure 6.8).
5. Install the mounting support of the BCL on the mounting base.



Danger of damaging the housing!

The maximum reach of the two fastening threads M6 is 7 mm. Longer screws will damage the housing.

- *Use screws of appropriate lengths.*

6. Screw the M6 screws through the mounting support into the fastening threads of the BCL.
7. Slightly tighten the screws.
8. Adjust the BCL as described below.

6.4 Mounting External Components

6.4.1 Mounting Modular Connector Unit MA 90

1. Mount the connector unit MA 90 near the BCL. Do not exceed a maximum distance of 10 m between the MA 90 and BCL.
2. Mount the MA 90 in such a way that the opened device is accessible at all times. The terminal interface of the BCL is accessed through the internal "Service" connector.



Notice!

For further details on mounting and electrical installation see data sheet of the modular connector unit MA 90.

6.4.2 Mounting the External Reading Cycle Sensor

When the BCL is triggered via an external sensor, the sensor must be mounted near the BCL. In the base setting, this type of trigger with the switched input "sensor" is selected as trigger. The debouncing time of the input is 30 ms in the base setting.

Figure 6.9 shows two examples of the mounting location of a retro-reflective photo electric sensor. The location depends on the distance a of the bar code to the front edge of the object. Depending on application, the sensor is to be mounted in such a way that bar codes on objects of different sizes can be completely scanned during the time window of the evaluation ("scan gate time").

Bar code in the middle or at the end of the transported object

Top view

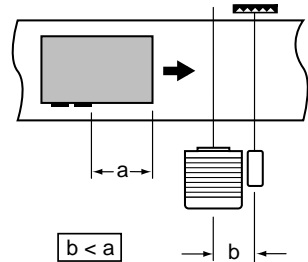
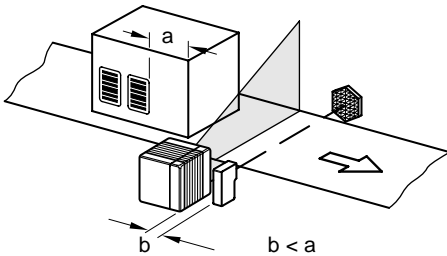

Bar code at the beginning of the transported object

Top view

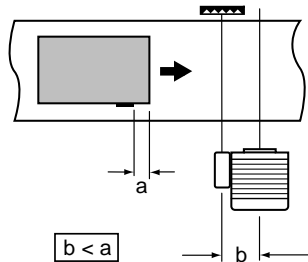
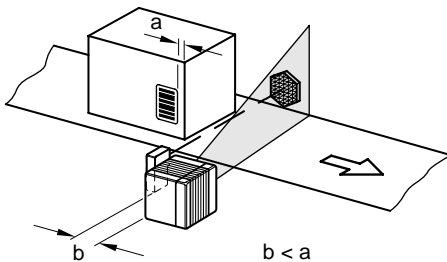

Figure 6.9: Line scanner: example for positioning the external reading cycle sensor when mounting

6.4.3 Mounting Sensors for Object Distance Detection

When the focus position switching of the BCL is triggered through external sensors, the respective sensors must be mounted near the BCL. Figure 6.10 shows an example of downward reading. The sensors are to be mounted in such a way that all possible object heights can be classified unambiguously and overlapping read areas (DOF) can be generated by the BCL. For this, a maximum of five switched inputs are available. A maximum of 32 switching status can be implemented for eight distance configurations (DOF) through the internal cross-reference list (combinations). Retro-reflective photo electric sensors, for example, are applied to detect the object distance. In the base setting, all five switched inputs "SE 2 ... SE 6" are selected for focus position switching.

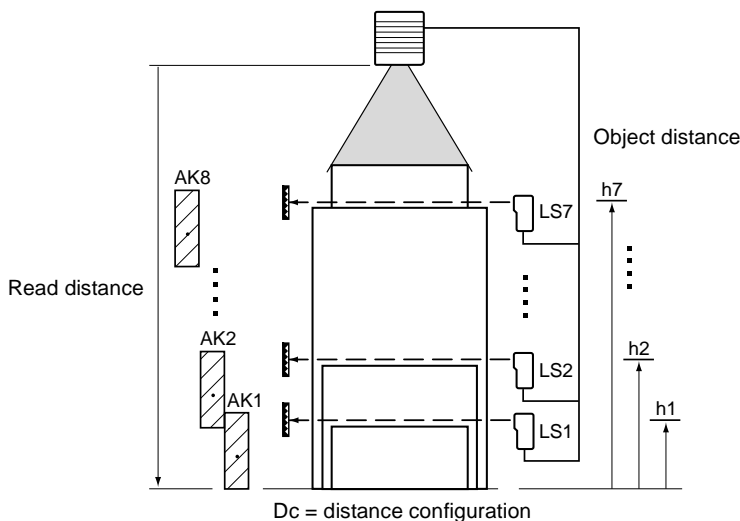

Figure 6.10: Example for positioning the object distance detection device when mounting

1. Look up the depths of field of the BCL for the given resolution of the bar code in the diagrams in Figure 4.3 to Figure 4.8 (line scanner) or Figure 4.9 to Figure 4.10 (line scanner with oscillating mirror) starting from Section 4.3, on page 32. Find and record the appropriate focus positions for overlapping DOF.
2. Place the distance sensors (e.g. retro-reflective photo electric sensors) for object height detection accordingly in a vertical row at the mounting site (see also Table 7.18, on page 93). We recommend mounting the distance sensors around 100 mm before the reading cycle sensor against the transporting direction.
3. Connect the distance sensors via the connection unit MA 90 to the switched inputs "SE 2 ... SE 6" of the BCL (see Section 7.5.6, on page 90).
4. Adjust the focus positions for the needed DOF through the user interface of BCL-Config.
5. Select the standard decoder and call up the percentage evaluation temporarily.
6. Check the reading quality for the distance configurations in statical operation (object not in transport motion)
7. Finally, check the function of distance detection in actual read operation of the application. For this purpose, observe the read result in the terminal emulator as in Section 6.4.2, on page 76.

Base setting: focus position F 1 to F 8 = 1200 mm



Notice!

The BCL can switch between a maximum of eight distance ranges for low-speed search functions by way of the integrated timer or oscillating mirror reversal points.

The BCL can switch between a maximum of eight distance ranges synchronous to the process through command strings.

7 Electrical Connection

7.1 Overview of the Installation Steps

- Connect the BCL 90 with a Leuze connector unit MA 90 or carry out the wiring according to customer specifications
- Carry out the connection of the data and function interfaces of the BCL in the module
- Connect the PC to the connection module (at the service interface of the BCL)
- Connect the connection module to the supply voltage

7.2 Electrical Connections and Cables

The BCL's electrical connection is comprised of two 15-pin D-Sub-HD plug connections, one device plug and one device socket installed on the housing.

The following interfaces are connected via these connectors:

- two serial data interfaces (host interface and terminal interface)
- six switched inputs (external reading cycle as well as multifunctional inputs)
- four switched outputs (output of result status functions, for connection e.g. to the PLC)
- CAN bus (for TPC operation)
- power supply

7.2.1 Core Cross-Sections

BCL without heater

- Wire all connections with copper cables with core cross-sections of at least 0.5 mm²!

BCL with heater

- Wire the power supply connections (pin 1/pin 5) with copper cables with core cross-sections of at least 0.75 mm² and maximum lengths of 10 m!

7.2.2 Pre-assembled Cables (Overview)

BCL type	Temp. range	Connector unit	Optional cables	Length	Kind	Type
BCL without heater	0...+40°C	MA 90	2 x No.500 35319 or	3 m	connecting cable	KB 090-3000
			1 x No. 500 35322	3 m	ext. parameter memory with cables	KB 090-3000P
		external power supply unit	1 x No. 500 35320 +	3 m	connection cable with open end	KB 090-3000B
			1 x No. 500 35321 or	3 m	connection cable with open end	KB 090-3000S
			1 x No. 500 35323 or	3 m	ext. parameter memory with cables	KB 090-3000PO
BCL with heater	-35...+35°C	MA 90	1 x No. 500 35324	3 m	plug cover IP 65 with cables	KB 090-3000H
		external power supply unit	1 x No. 500 35325	3 m	plug cover IP 65 with cables	KB 090-3000HO

Table 7.1: Cables for the connection of the BCL

For technical data of the cables see Section 5.2.1, on page 68.

7.2.3 Connections/Cables for the Modular Connector Unit MA 90

The connector unit MA 90 is suited for connecting the BCL to peripherals (distributor function) and power supply in industrial applications. This unit makes it possible to implement a direct connection to the host (point-to-point) and an integration in the Leuze network.

Figure 7.1 shows an example of the principle of connecting the MA 90 to a BCL.

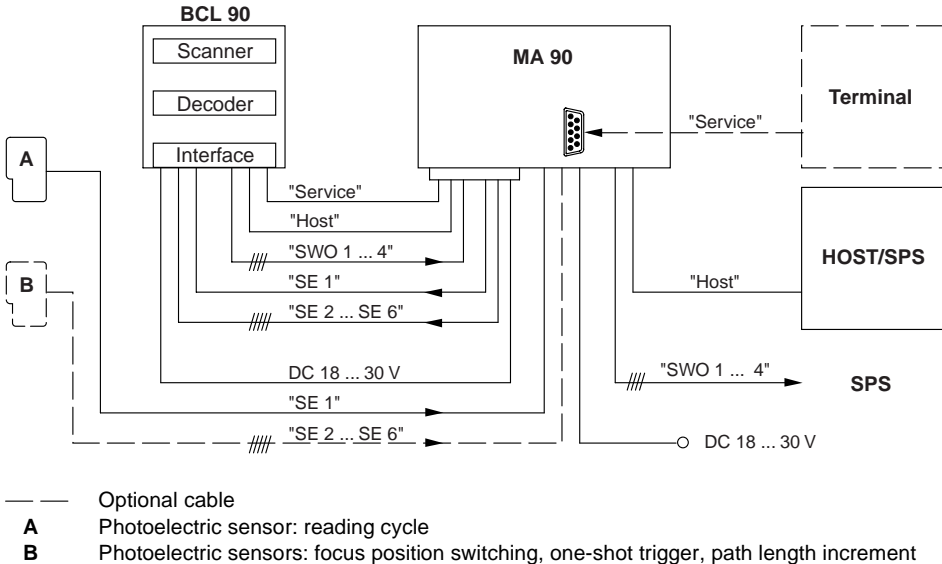

Figure 7.1: Block diagram: connecting the BCL to the connector unit MA 90

Connecting the BCL 90 to the MA 90:

Two cables KB090-3000 No. 500 35 319 are required to connect the BCL. An alternative connection path can be via the external parameter memory KB090-3000P No. 500 35 322.

a) BCL without heater:

Connector unit MA 90

The cables KB090-3000 No. 500 35 319 can be extended to up to 10 m (terminal interface: RS 232!).

b) BCL with heater

Connector unit MA 90

The cables KB090-3000 No. 500 35 319 may not be extended!

If greater lengths are required, the power supply (pin 1/pin 5) are to be wired with a total core cross-section of at least 0.75 mm² at max. 10 m length.



Recommendation!

Use cable KB090-3000H No. 500 35 324 (with two plug covers, length 3 m) for the connection.

7.3 Pin Assignment of the Connections

7.3.1 Connections of the BCL

Device plug connector: "host/term" connection

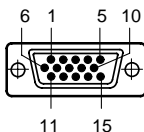

Pin	Signal	Function
1 ¹⁾	V _s	Supply voltage
2	RxD (RS 232), maintenance	Service interface (receiver)
3	TxD (RS 232), maintenance	Service interface (transmitter)
4	Term (RS 422/485)	Termination of the host interface
5	GND	Ground
6	RD+ (RS 422/485), host	Host interface (receiver+)
7	RD- (RS 422/485), host RxD (RS 232), host	Host interface (receiver-)
8	TD+ (RS 422/485), host	Host interface (transmitter+)
9	TD- (RS 422/485), host TxD (RS 232), host	Host interface (transmitter-)
10	CAN H	CAN bus (IN/OUT)
11	Bus RT_485-	
12	Bus RT_485+	
13	Bus R_485-	
14	Bus R_485+	
15	CAN L	CAN bus (IN/OUT)
Housing		Shield

¹⁾ Pin 1 is bridged in the BCL with pin 1 of the "I/O" connection

Table 7.2: Pin assignment of the 15-pin D-Sub-HD "host/term" device plug connector

Device socket connector: "I/O" connection

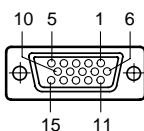

Pin	Signal	Function
1 ¹⁾	V _s	Supply voltage
2	SE 3	Switched input (trigger focus position switching)
3	SE 1	Switched input (external reading cycle generator)
4	SWO 1	Switched output, adjustable function
5	GND	Ground
6	SE 2	Switched input (trigger focus position switching)
7	SE 4	Switched input (trigger focus position switching)
8	SWO 2	Switched output, adjustable function
9	INGND	Common ground for all switched inputs
10	SWO 3	Switched output, adjustable function
11	SE 5	Switched input, adjustable function
12	SE 6	Switched input, adjustable function
13	IC2 SDA	I2C bus
14	IC2 SCL	I2C bus
15	SWO 4	Switched output, adjustable function
Housing		Shield

¹⁾ Pin 1 is bridged in the BCL with pin 1 of the "host/term" connection

Table 7.3: Pin assignment of the 15-pin D-Sub-HD "I/O" device socket connector

**7.3.2 Ext. Parameter Memory KB090-3000P No. 500 35 322 (Optional)
Plug Cover KB090-3000H No. 500 35 324 (Optional)**

Cable plug connector: "host/term" connection

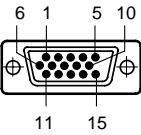

Pin	Signal	Function
1 ¹⁾	V _s	Supply voltage
2	RxD (RS 232), maintenance	Service interface (receiver)
3	TxD (RS 232), maintenance	Service interface (transmitter)
4	Term (RS 422/485)	Termination of the host interface
5	GND	Ground
6	RD+ (RS 422/485), host	Host interface (receiver+)
7	RD- (RS 422/485), host RxD (RS 232), host	Host interface (receiver-)
8	TD+ (RS 422/485), host	Host interface (transmitter+)
9	TD- (RS 422/485), host TxD (RS 232), host	Host interface (transmitter-)
10	CAN H	CAN bus (IN/OUT)
11	Bus RT_485-	
12	Bus RT_485+	
13	Bus R_485-	
14	Bus R_485+	
15	CAN L	CAN bus (IN/OUT)
Housing		Shield

¹⁾ Pin 1 is bridged in the BCL with pin 1 of the "I/O" connection

Table 7.4: Pin assignment of the 15-pin D-Sub-HD "host/term" cable plug connector

Device socket connector: "I/O" connection

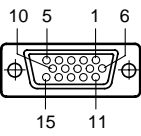

Pin	Signal	Function
1 ¹⁾	V _s	Supply voltage
2	SE 3	Switched input (trigger focus position switching)
3	SE 1	Switched input (external reading cycle generator)
4	SWO 1	Switched output, adjustable function
5	GND	Ground
6	SE 2	Switched input (trigger focus position switching)
7	SE 4	Switched input (trigger focus position switching)
8	SWO 2	Switched output, adjustable function
9	INGND	Common ground for all switched inputs
10	SWO 3	Switched output, adjustable function
11	SE 5	Switched input, adjustable function
12	SE 6	Switched input, adjustable function
13	IC2 SDA	I2C bus
14	IC2 SCL	I2C bus
15	SWO 4	Switched output, adjustable function
Housing		Shield

¹⁾ Pin 1 is bridged in the BCL with pin 1 of the "host/term" connection

Table 7.5: Pin assignment of the 15-pin D-Sub-HD "I/O" cable socket connector

7.4 Preparing the Electrical Installation

7.4.1 Conditions for Using the Host Interface

Both the RS 422/485 and the RS 232 types can be used as the host interface of the BCL. Table 7.6 shows the recommended maximum cable lengths depending on the selected data transmission rate.

Type of interface	Transmission rate	Distance to the host
RS 232	up to 19 200 bits/s	up to 10 m
	38 400 ... 57 600 bits/s	up to 3 m
RS 422/485 ¹⁾	up to 38 400 bits/s	up to 1200 m
	up to 57 600 bits/s	up to 500 m

¹⁾ with corresponding cable termination

Table 7.6: Maximum cable lengths between the BCL and the host



Notice!

In order to avoid disturbances, do not lay the cable in parallel to power supply and motor cables over longer distances e.g. in cable trays.

7.4.2 Supply Voltage

For operation without heater, the BCL needs a supply voltage of

DC 18 ... 30 V, with heater DC 24 V + 20% / -10% acc. to IEC 742 (functional low voltage). Depending on scanning technology, it has the following power consumption:

Model	Voltage	Scan technology	Heater	Power consumption ¹⁾	Connector units
BCL 90	DC 18 ... 30 V	Line scanner	no	typically 9 W/max. 16 W	MA 90
		Line scanner with oscillating mirror	no	typically 9 W/max. 18 W	
	DC 24 V	Line scanner	yes	typically 75 W/max. 90 W	MA 90
		Line scanner with oscillating mirror	yes	typically 75 W/max. 100 W	

¹⁾ for unconnected switched outputs

Table 7.7: Power consumption of the BCL

7.4.3 External Power Supply Unit/Wiring without Connector Unit

Power output

In case an external power supply unit is used for power supply instead of the MA 90, the power supply unit should be able to have the following voltage and power output:

- for BCL without heater: DC 18 ... 30 V, at least 20 W continuous power
- for BCL with heater: DC 24 V +20% / 10%, at least 100 W continuous power

The external power supply unit has to correspond to standard number IEC 742 (functional extra-low voltage).

The output circuit should have a reliable electrical isolation against the input circuit according to IEC 742 consisting of a double isolation and safety transformer.

Core cross-section

The core cross-section for the power supply line (pin 1/pin 5) should be at least 0.5 mm², for BCLs with heaters, at least 0.75 mm² at a maximum length of 10 m.

a) Connection of the BCL without plug cover/without external parameter memory

The two cables KB 090-3000B No. 500 35 320 and KB 090-3000S No. 500 35 321 with open end at one side are required for connecting the BCL. The core colour coding is shown in Table 7.8 and Table 7.9. For BCLs with heaters, the cables may not be extended.

Connection cable KB 090-3000B No. 500 35 320 ("host/term" connection)

15-pin D-Sub-HD socket and open cable end

Pin	Signal	Core colour
1 ¹⁾	V _s	red
2	RxD (RS 232), maintenance	white
3	TxD (RS 232), maintenance	brown
4	Term (RS 422/485)	purple
5	GND	blue
6	RD+ (RS 422/485), host	green
7	RD- (RS 422/485), host RxD (RS 232), host	yellow
8	TD+ (RS 422/485), host	grey
9	TD- (RS 422/485), host TxD (RS 232), host	pink
10	CAN H	-
11	Bus RT_485-	-
12	Bus RT_485+	-
13	Bus R_485-	-
14	Bus R_485+	-
15	CAN L	-
-	Shield	orange

¹⁾ Pin 1 is bridged in the BCL with pin 1 of the "I/O" connection

Table 7.8: Core colour coding of cable KB 090-3000B No. 500 35 320

Connection cable KB 090-3000S No. 500 35 321 ("I/O" connection)

15-pin D-Sub-HD plug connector and open cable end

Pin	Signal	Core colour
1 ¹⁾	V _s	red
2	SE 3	white
3	SE 1	brown
4	SWO 1	purple
5	GND	blue
6	SE 2	green
7	SE 4	yellow
8	SWO 2	grey
9	INGND	black
10	SWO 3	grey-pink
11	SE 5	red-blue
12	SE 6	white-green
13	IC2 SDA	brown-green
14	IC2 SCL	white-yellow
15	SWO 4	yellow-brown
-	Shield	orange

¹⁾ Pin 1 is bridged in the BCL with pin 1 of the "host/term" connection

Table 7.9: Core colour coding of cable KB 090-3000S No. 500 35 321

b) Connection of the BCL with ext. parameter memory KB 090-3000PO No. 500 35 323

BCL without heater:

- Cover the "host/term" and "I/O" connections of the BCL with the plug cover (parameter memory) No. 1500 35 323. Wire the free cable ends accordingly. The core colour coding is shown in Table 7.10 and Table 7.11.

BCL with heater:

- No external parameter memory available.

Table 1 ("host/term" connection)

15-pin D-Sub-HD socket in the plug cover and open cable end

Pin	Signal	Core colour
1 ¹⁾	V _s	red and pink
2	RxD (RS 232), maintenance	white
3	TxD (RS 232), maintenance	brown
4	Term (RS 422/485)	purple
5	GND	blue and grey-brown
6	RD+ (RS 422/485), host	green
7	RD- (RS 422/485), host RxD (RS 232), host	yellow
8	TD+ (RS 422/485), host	grey
9	TD- (RS 422/485), host TxD (RS 232), host	black
10	CAN H	grey-pink
11	Bus RT_485-	red-blue
12	Bus RT_485+	white-green
13	Bus R_485-	brown-green
14	Bus R_485+	white-yellow
15	CAN L	yellow-brown
-	Shield	orange

¹⁾ Pin 1 is bridged in the BCL with pin 1 of the "I/O" connection

Table 7.10:Core colour coding of cable 1 of the ext. parameter memory KB 090-3000PO No. 500 35 323

Table 2 ("I/O" connection)

15-pin D-Sub-HD plug connector in the plug cover and open cable end

Pin	Signal	Core colour
1 ¹⁾	V _s	red and pink
2	SE 3	white
3	SE 1	brown
4	SWO 1	purple
5	GND	blue and grey-brown
6	SE 2	green
7	SE 4	yellow
8	SWO 2	grey
9	INGND	black
10	SWO 3	grey-pink
11	SE 5	red-blue
12	SE 6	white-green
13	IC2 SDA	-
14	IC2 SCL	-
15	SWO 4	yellow-brown
-	Shield	orange

¹⁾ Pin 1 is bridged in the BCL with pin 1 of the "host/term" connection

Table 7.11:Core colour coding cable 2 of the ext. parameter memory KB090-3000PO No. 500 35 323

c) Connection with plug cover KB 090-3000HO No. 500 35 325

- Cover the "host/term" and "I/O" connections of the BCL with plug cover KB090-3000HO No. 500 35 325 and wire the free cable ends accordingly. The core colour coding is shown in Table 7.12 and Table 7.13.

BCL with heater:

The plug cover can be used under a temperature of max. -50° as long as the BCL is permanently installed and the cables remain immobile. Max. -40 °C are possible if the cables move along with the position changes of the BCL.

Table 1 (power supply connection)

15-pin D-Sub-HD socket in the plug cover and open cable end

Pin	Plug cover	Signal	Core colour
1	Socket	V _s	red
5	Socket	GND	black

Table 7.12:Core colour coding of cable 1 of plug cover KB 090-3000HO No. 500 35 325

Table 2 (data and function interface connection)

15-pin D-Sub-HD socket in the plug cover and open cable end

Pin	Plug cover	Signal	Core colour
2	Plug connector	SE 3	white
3	Plug connector	SE 1	brown
4	Plug connector	SWO 1	green
6	Plug connector	SE 2	yellow
7	Plug connector	SE 4	grey
8	Plug connector	SWO 2	pink
9	Plug connector	IN GND	blue
10	Plug connector	SWO 3	red
11	Plug connector	SE 5	black
12	Plug connector	SE 6	purple
15	Plug connector	SWO 4	grey-pink
2	Socket connector	RxD (RS 232), maintenance	red-blue
3	Socket connector	TxD (RS 232), maintenance	white-green
4	Socket connector	Term (RS 422/485)	brown-green
6	Socket connector	RD+ (RS 422/485), host	white-yellow
7	Socket connector	RD- (RS 422/485), host RxD (RS 232), host	yellow-brown
8	Socket connector	TD+ (RS 422/485), host	white-grey
9	Socket connector	TD- (RS 422/485), host TxD (RS 232), host	grey-brown
-		Shield	orange

Table 7.13:Core colour coding of cable 2 of plug cover KB 090-3000HO No. 500 35 325

7.5 Electrical Installation

7.5.1 Overview of the Connection Steps

- Connect supply voltage
- Connect host interface
- Connect PC (terminal interface)
- Connect switched inputs "SE 1" and "SE 2 ... SE 6"
- Connect switched outputs "SWO 1 ... SWO 4"

7.5.2 Supplementary Devices

- Tools
- Digital measuring device (ammeter/voltmeter)

7.5.3 Connect supply voltage

Modular connector unit MA 90

When the BCL has its power supplied via the Leuze connector unit, the supply voltage needs not be individually wired.

Connection of the BCL without external parameter memory:

1. Make sure that the supply voltage of the connector unit is switched off.
2. Connect the two "host/term" and "I/O" connections of the BCL via the two cables KB 090-3000 No. 500 35 319 to the corresponding connections on the connector unit and screw down on both sides.

Connection of the BCL with external parameter memory:

1. Place the plug cover with the external parameter memory KB 090-3000P No. 500 35 322 over the "host/term" and "I/O" connections of the BCL and screw down. Connect the two free plug connections of the cables with the corresponding connections on the connector unit and screw down.

The data and function interfaces of the BCL have contact with the connector unit.

Power supply via the external power supply unit

Connection of the BCL without external parameter memory:

1. Plug the cable socket of cable KB 090-3000B No. 500 35 320 on the "host/term" connection and screw down.
2. Plug the cable plug of cable KB 090-3000S No. 500 35 321 on the "I/O" connection and screw down.
3. Connect the power supply to the red core (pin 1, VS) and the blue core (pin 5, GND) of cable KB 090-3000B No. 500 35 320. Also see Table 7.8, on page 84.

Connection of the BCL with external parameter memory:

1. Place the plug cover with the external parameter memory KB 090-3000PO No. 500 35 323 on the "host/term" and "I/O" connections of the BCL and screw down.
2. Connect the power supply to the red/pink core (pin 1, VS) and the blue/grey-brown core (pin 5, GND) of cable 1. Also see Table 7.10, on page 86.

The BCL is connected to the power supply.

7.5.4 Connect the BCL 90 host interface

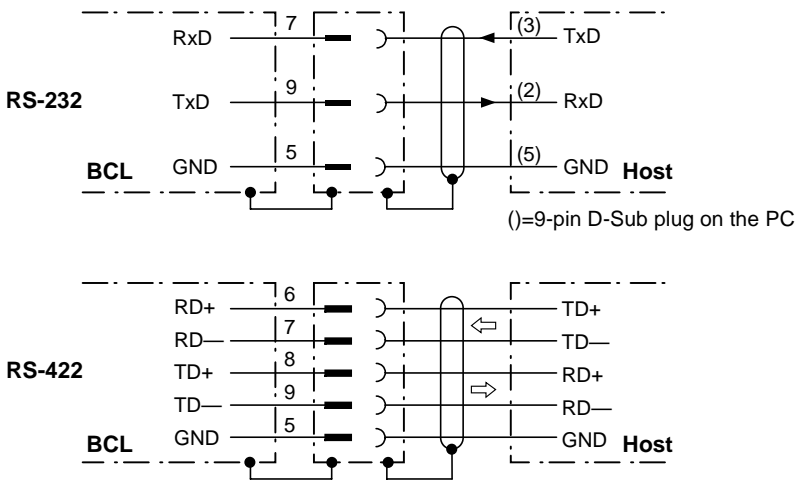

Figure 7.2: Circuitry of the host interface



Damage to the interface module!

Incorrect connection of the host interface may lead to damage to electronic components in the BCL. This also applies to the adjustment of the host interface connection in the connector units (configuration).

- Correctly connect the host interface acc. to Figure 7.2.
- Carefully check the circuitry before switching on the BCL.

1. Connect the host interface of the BCL acc. to EMC via shielded cables to the host. At the same time, keep the maximum cable lengths in mind (see Table 7.6, on page 83).
2. Mount the shielding on one end

In the base setting, the BCL communicates with the host via the host interface of which the parameters are listed in Table 7.14.

Parameter	Value
Type	RS 232
Data transmission rate	9600 bit/s
Data bit/parity	8/none
Stop bit	1
Protocol	Prefix 1: STX Postfix 1: CR Postfix 2: LF

Table 7.14: Communication parameter of the host interface (base setting)



Notice!

For connecting the host interface via the connector unit MA 90 see data sheet MA 90.

7.5.5 Connect the PC

The BCL is operated and configured with the PC software BCL-Config. To this end, it has to be connected to the PC via the service interface (auxiliary interface). In contrast to the host interface, the service interface has a permanent data format and a predefined data transmission rate. Figure 7.3 shows the circuitry of the service interface. The cable length should not exceed 10 m.

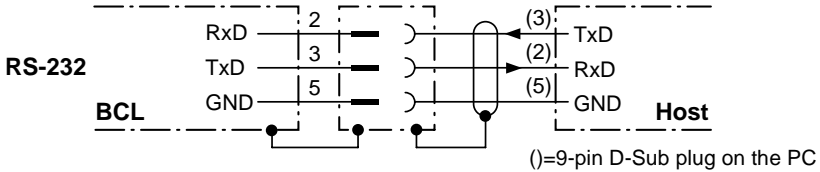

Figure 7.3: Circuitry of the service interface

1. Turn on the PC and the supply voltage of the MA 90.
2. Connect the PC with the internal, 9-pin "Service" plug of the MA 90. Use an RS 232 connection cable for this (RxD and TxD crossed).
- or -
in case no MA 90 is used: connect the PC acc. to Figure 7.3.
3. Turn on the PC and the supply voltage of the MA 90.
4. Adjust the communication parameters.

7.5.6 Connect the Switched Inputs

Connect the switched input "SE 1"

Should a read process of the BCL be triggered through an external sensor, the reading cycle sensor is to be connected to the switched input "SE 1". The type of triggering is selected as base setting of the BCL. Figure 7.4 shows the circuitry of the switched input "SE 1". Table 7.15 contains the characteristics for this input.

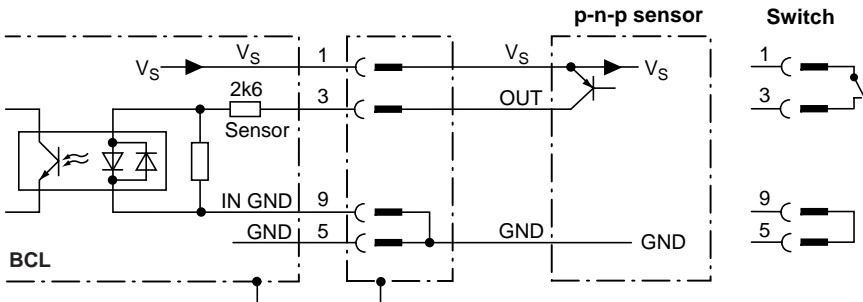

$V_s = DC +18 \dots +30 \text{ V}$ for BCL without heater, $DC 24 \text{ V} +20\% / -10\%$ for BCL with heater

Figure 7.4: Circuitry of the switched input "SE 1"

- Connect the reading cycle sensor as shown in Figure 7.4.

Switching characteristics	Power at the input sets off the scan gate time of the BCL. (Base setting: active high, debouncing: 20 ... 30 ms (standard))
Features	- with opto-coupler, polarity-proof - can be connected to the p-n-p output of a sensor
Electrical values	Low: $-30\text{ V} \leq U_e \leq +2\text{ V}$ High: $+7\text{ V} \leq U_e \leq +13\text{ V}$

Table 7.15: Characteristics of the switched input "SE 1"



Notice!

For the connection of the switched input "SE 1" via the connector unit MA 90 see data sheet

Connect the switched inputs "SE 2 ... SE 6"

If the autofocus function is not used and the focus position switching of the BCL is to be triggered through external sensors, the sensors are connected to the five inputs SE 2 ... SE 6. The inputs, together with the internal cross-reference list (combination table), results in up to 32 switching states for a maximum of 8 distance configurations. In the base setting, the function "focus position switching" is selected for all inputs.

Additional function of SE 5

The input SE 5 can also alternatively serve as trigger for the one-shot function of the oscillating mirror.

Additional function of SE 6

The input SE 6 can also alternatively serve as trigger for the one-shot function of the oscillating mirror or as input for a band increment signal. Up to 16 switching states then remain for focus position switching.

Figure 7.5 shows the circuitry of the switched inputs SE 2 ... SE 6. Table 7.16 contains the pin assignment at the BCL. Table 7.17 describes the characteristics for the inputs. Table 7.18 represents the combinations of the inputs and their relations to the distance configurations. Table 7.19 shows the combined effect of the functions of the switched inputs.

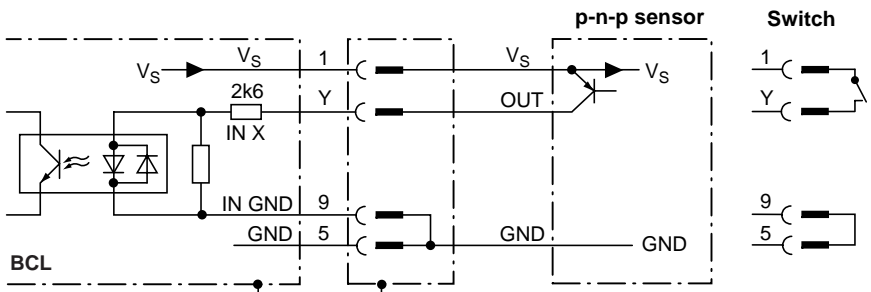

$V_S = \text{DC } +18 \dots +30\text{ V}$ for BCL without heater, DC 24 V +20% / -10% for BCL with heater

Figure 7.5: Circuitry of the switched inputs "SE 2... SE 6"

Input (SE X)	BCL "I/O" connection (pin Y)
SE 2	Pin 6
SE 3	Pin 2
SE 4	Pin 7
SE 5	Pin 11
SE 6	Pin 12

Table 7.16: Pin and terminal assignment of the switched inputs "SE 2 ... SE 6"

- Connect the sensors as shown in Figure 7.5.



Notice!

For the connection of the switched output via the connector unit MA 90 see data sheet MA 90.

Function	Trigger for focus position switching SE 5 alternatively: - trigger for one-shot of the oscillating mirror SE 6 alternatively: - trigger for one-shot of the oscillating mirror - band increment input Base setting SE 5 and SE 6: focus position switching
Switching characteristics	Active when input is high
Features	- with opto-coupler, polarity-proof - can be connected to the p-n-p output of a sensor
Electrical values	Low: $-30\text{ V} \leq U_e \leq +2\text{ V}$ High: $+7\text{ V} \leq U_e \leq +13\text{ V}$

Table 7.17: Characteristics of the switched inputs "SE 2 ... SE 6"

Switched input		Content from the cross-reference list for distance config. 2)	
Logical states of the inputs 1) SE 6 ... SE 2	Cross-reference-list index	Base setting	Example: photoelectric sensors (light switching)
0 0 0 0 0	N 1	DC 1	DC 6
0 0 0 0 1	N 2	DC 2	DC 5
0 0 0 1 0	N 3	DC 3	DC 4
0 0 0 1 1	N 4	DC 4	DC 4
0 0 1 0 0	N 5	DC 5	DC 3
0 0 1 0 1	N 6	DC 6	DC 3
0 0 1 1 0	N 7	DC 7	DC 3
0 0 1 1 1	N 8	DC 8	DC 3
0 1 0 0 0	N 9	DC 8	DC 2
0 1 0 0 1	N 10	DC 8	DC 2
0 1 0 1 0	N 11	DC 8	DC 2
0 1 0 1 1	N 12	DC 8	DC 2
0 1 1 0 0	N 13	DC 8	DC 2
0 1 1 0 1	N 14	DC 8	DC 2
0 1 1 1 0	N 15	DC 8	DC 2
0 1 1 1 1	N 16	DC 8	DC 2
1 0 0 0 0	N 17	DC 8	DC 1
1 0 0 0 1	N 18	DC 8	DC 1
1 0 0 1 0	N 19	DC 8	DC 1
1 0 0 1 1	N 20	DC 8	DC 1
1 0 1 0 0	N 21	DC 8	DC 1
1 0 1 0 1	N 22	DC 8	DC 1
1 0 1 1 0	N 23	DC 8	DC 1
1 0 1 1 1	N 24	DC 8	DC 1
1 1 0 0 0	N 25	DC 8	DC 1
1 1 0 0 1	N 26	DC 8	DC 1
1 1 0 1 0	N 27	DC 8	DC 1
1 1 0 1 1	N 28	DC 8	DC 1
0 0 0 0 0	N 29	DC 8	DC 1
0 0 1 0 1	N 30	DC 8	DC 1
0 0 1 1 0	N 31	DC 8	DC 1
1 1 1 1 1	N 32	DC 8	DC 1

1) 1 = energised (active); 0 = de-energised (inactive) 2) distance configuration (DC): data set for a focus position

Table 7.18: Focus position switching: cross-reference list for switched inputs - distance configuration

Parameterization of the switched inputs		Effect
SE 5	SE 6	
Focus position switching ¹⁾	Focus position switching ¹⁾	SE 5 switches focus position in combination with SE 2 ... SE 4 and SE 6
Focus position switching ¹⁾	One-shot	SE 6 triggers the one-shot SE 5 switches focus position in combination with SE 2 ... SE 4
Focus position switching ¹⁾	Increment counter	SE 6 receives increment signals SE 5 switches focus position in combination with SE 2 ... SE 4
One-shot	Focus position switching ¹⁾	SE 5 triggers the one-shot SE 2 ... SE 4 switches focus position SE 6 remains ineffective
One-shot	One-shot	SE 6 triggers the one-shot SE 2 ... SE 4 switches focus position SE 5 remains ineffective
One-shot	Increment counter	SE 5 triggers the one-shot SE 6 receives increment signals SE ... SE 4 remains ineffective
¹⁾ varying with the cross-reference list		

Table 7.19:Function combination of the switched inputs SE 2 ... SE 6

7.5.7 Connect Switched Outputs "SWO 1 ... SWO 4"

The four switched outputs can be individually assigned different functions of the result status output. When an event occurs during the read process, the switched output corresponding to this particular event will become energised after the end of the reading cycle for the selected pulse duration. The pulse duration can be adjusted separately for each output.

The "Result" LED is coupled with the output "SWO 2" and is switched on in the operating mode "read operation" for the adjusted pulse duration and selected function of the result status display (base setting: "Good Read", 100 ms).

Figure 7.6 shows the circuitry of the switched outputs "SWO 1 ... SWO 4". Table 7.20 contains the pin assignment on the BCL. Table 7.21 describes the characteristics for the outputs. The characteristics of the four outputs are the same.

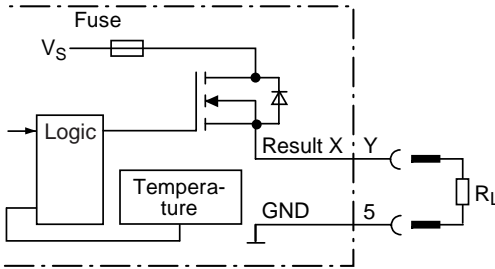

Pulse duration depending on the setting:

- 10 ms ... 990 ms
- 100 ms ... 9900 ms
- 00: statical (to the end of the next reading cycle)

$V_S =$ DC +18 ... +30 V for BCL without heater,
DC 24 V +20% / -10% for BCL with heater

Figure 7.6: Circuitry of the switched outputs "SWO 1 ... SWO 4"

Output (result X)	BCL "I/O" connection (pin Y)
SWO 1	Pin 4
SWO 2	Pin 8
SWO 3	Pin 10
SWO 4	Pin 15

Table 7.20: Pin and terminal assignment of the switched outputs "SWO 1 ... SWO 4"

Connect the outputs as shown in Figure 7.6.

Function assignment (base setting)	SWO 1: "Device Ready" (statical), polarity: not inverted SWO 2: "Good Read", polarity: not inverted SWO 3: "No Read", polarity: not inverted SWO 4: "Match 1", polarity: not inverted Pulse duration: 400 ms each
Switching characteristics	p-n-p connected against the supply voltage V_S
Features	the current is limited to 0.7 A during short circuit
Electrical values	$0\text{ V} \leq U_a \leq 30\text{ V}$ Guaranteed: $U_a \leq V_S - 1.3\text{ V}$ at $I_a \leq 100\text{ mA}$ $I_a \leq 100\text{ mA}$

Table 7.21: Characteristics of the switched outputs "SWO 1 ... SWO 4"



Notice!

In the function "Device Ready", the output supplies a statical pulse when the BCL is in read operation. For the connection of the switched output via the connector unit MA 90 see data sheet MA 90.



Notice!

To check the switching functions with a high-resistance digital voltmeter, connect the outputs to a load. This measure serves to avoid a display of incorrect voltages/switching states.

8 Operation

8.1 Overview of the Commissioning Steps

- Commissioning the BCL with factory default setting (quick-start).
In this configuration, the BCL can be operated without connecting it to a PC.
- Configuration (parameterization) of the BCL for application with BCL-Config or command strings

8.2 Base Setting

Table 8.1 and Table 8.2 show an overview of the factory default setting of the BCL. The parameters of the base setting are selected in such a way that the BCL can be used in this configuration directly or only with small adjustments in many applications. A PC is not needed for commissioning with the base setting

The base setting values are permanently stored both in the BCL (ROM) and in the database of BCL-Setup. They can be downloaded any time in the operating memory (RAM) of the BCL or displayed in the tabs of BCL-Config.

8.2.1 Base Setting of the Line Scanner BCL 90 (All Models)

Parameter	Base setting
Decoder	CRT decoder
Active code types	Codabar, Code 39, 2/5 Interleaved, Code 128
Code length	unlimited (2/5 Interleaved: interval 4 ... 50 characters)
Start/stop conditions	automatically
Min./ max. code position	5/ 95 CP
Multiple reading	3
Min./ max. number of codes	1
Scanning frequency	800 Hz
Autofocus mode	smallest distance
- Range	400 ... 2200 mm
- Scanning angle	-30° ... +30°
- Focus position switching trigger	autofocus, immediate/synchronous switching
Reading cycle source	start: switched input "SE 1" (active: high); end: switched input "SE 1"
Switched inputs SE 2 ... SE 6	without autofocus function
Switched input "SE 1"	start and stop of the reading cycle (level: active high), debouncing 20 ... 30 ms
Switched outputs	not inverted; pulse duration: 100 ms
- Status output function	SWO 1: "Device Ready" (statical); SWO 2: "Good Read"; SWO 3: "No Read"; SWO 4: "Match 1"
Arrangement to the host	stand alone
Device number	1
Start option	download parameter set from the external parameter memory

Table 8.1: Excerpt: base setting of the parameter values of the BCL 90

Parameter	Base setting
- Host interface (type)	RS 232
- Protocol	NAK; start signal: STX, stop signal: CR, LF
- Transmission rate	9600 bits/s
- Data format:	8 data bits, no parity, 1 stop bit
- Output format	header: empty, separator: ST, terminator: CR LF; error string: only separator
- Output sorting	acc. to code position
- Output time	read result: clocking separator: acc. to code
- Test string	not active
Terminal interface	RS 232, 9600 baud, 8 data bits, no parity, 1 stop bit (values unalterable)
Function	Read diagnosis

Table 8.1: Excerpt: base setting of the parameter values of the BCL 90 (Cont.)

8.2.2 Base Setting of the Line Scanner BCL 90 with Oscillating Mirror (All Models)

Base setting as in line scanner BCL 90 except for the following additions:

Parameter	Base setting
Oscillation amplitude	± 40 CW (corresponds to a deflection angle of $-20^\circ \dots +20^\circ$)
Operating mode	oscillating at predefined amplitude, separate from reading cycle triggering
Oscillation frequency	1 Hz
Predefined position	50 CW (corresponds to a light exit angle smaller than 105°)

Table 8.2: Excerpt: base setting of parameter values of BCL 90 with oscillating mirror

8.3 Display and Operating Elements

8.3.1 Operating Elements

The BCL is operated and configured via the service interface (auxiliary interface) using the PC software BCL-Config or via the host interface/service interface using command strings. A great variety of parameterization options allows it to be adapted to the most diverse applications.

Among others options, adjustments can be made to the following:

- Configuration of the code types to be read
- Reading, evaluation and output characteristics
- Communication parameters of the host interface
- Structure of the data output string of the host interface for Good Read and No Read
- Function of the terminal interface

8.3.2 Function of the LED Indicators

Four LED indicators optically reports on operating status, laser diode activities, read result status and data transmission on the host interface. The LED indicators (Figure 8.1) are located on the back of the device.

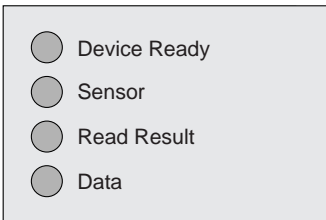

Figure 8.1: LED indicators

When the optional external parameter memory is connected, the LEDs assume the additionally duty of signalling by way of their display patterns the success of accessing the external parameter memory.

Table 8.3 and Table 8.4 list the meaning of the LED indicators in the various operating modes/functions.

BCL without external parameter memory

Operating mode	LED	Indicator	Function
Start	Device Ready	green	<ul style="list-style-type: none"> lights up after switching on, after a successful self test
Read operation	Device Ready Sensor	green	<ul style="list-style-type: none"> constant light goes out at change into another operating mode/function
	Read Result	green	<ul style="list-style-type: none"> lights up when the laser diode for reading is active. (The laser diode is switched on and off through read clocking) lights up constantly in the clocking type "free oscillating", as the laser diode is continuously active <p>LED is coupled with the switched output "SWO 2". It indicates the result status selected at the output for the set pulse duration.</p> <ul style="list-style-type: none"> lights up after a successful reading (base setting: Good Read) lights up when code comparison is activated, the scanned bar code is identical to the predefined comparison code(s) and the corresponding result status output is selected at the output "SWO 2".
	Data	yellow	<ul style="list-style-type: none"> flimmers when the BCL transfers data to the host at the host interface
Percentage evaluation	Sensor	green	<ul style="list-style-type: none"> lights up constantly due to free-oscillating operation
	Read Result	green	<p>Behaviour depends on read rate:</p> <ul style="list-style-type: none"> goes out when the read rate < 30% blinks twice per second when the reading rate is 30% to 70% blinks five times per second when the reading rate is 70% to 90% constant light when the reading rate > 90%
Calibrating help	Sensor	green	<ul style="list-style-type: none"> lights up constantly due to free-oscillating operation
Show CP limits	Sensor	green	<ul style="list-style-type: none"> blinks alternately light/dark in the rhythm in which the scan line is partially covered up

Table 8.3: Meaning of the LED indicators: BCL without external parameter memory

BCL connected to external parameter memory

Operating mode	LED	Indicator	Function
Start	Device Ready	green	<ul style="list-style-type: none"> lights up after switching on, after a successful self test <p>subsequent behaviour depends on the selected start option: start option: "Start with external parameters" (base setting):</p> <ul style="list-style-type: none"> blinks around 10 s, then constant light. (BCL successfully downloaded the parameter set from the external parameter memory and immediat. starts the reading operation) blinks around 10 s together with the LED "Read Result", then constant light. (BCL successfully downloaded the parameter set from the external parameter memory with tolerated deviations¹⁾ and immediately starts the read operation) constant light. (BCL could not find any external parameter memory and instead downloaded the internal parameter set) blinks continuously together with the LED "Read Result"²⁾. (The external parameter memory is either empty, contains the parameter set of another BCL model or is not functional). BCL downloaded the internal parameter set. It starts the read operation, but does not output any data via the host interface <p>Start option: "Start with internal parameters":</p> <ul style="list-style-type: none"> lights up constantly (BCL downloaded the internal parameter set) <p>Start option: "Start with copying from internal to external":</p> <ul style="list-style-type: none"> blinks around 10 s alternately with the LED "Read Result", then constant light. (BCL successfully copied the internal parameter set into the external memory and reset the option for the next start to "Start with external parameters"). BCL downloaded the internal parameter set blinks continuously together with the LED "Read Result"²⁾ (The external parameter memory is either not connected or defective, or the parameter set to be copied is too large). BCL downloaded the internal parameter set
	Read Result	green	<p>Start option: "Start with external parameters" (base setting):</p> <ul style="list-style-type: none"> blinks for about 10 s tog. with LED "Device Ready"¹⁾ (see above) or blinks continuously tog. with LED "Device Ready"²⁾ (see above) <p>Start option: "Start with copying from internal to external":</p> <ul style="list-style-type: none"> blinks for 10 s alternately with LED "Device Ready" (see above) or blinks continuously tog. with LED "Device Ready"²⁾ (see above)

Table 8.4: Meaning of the LED indicators: BCL connected to ext. parameter memory.

Operating mode	LED	Indicator	Function	
Read operation	Device Ready	green	<ul style="list-style-type: none"> constant light goes out at change into another operating mode/function lights up when the laser diode for reading is active. (The laser diode is switched on and off through read clocking) lights up constantly in the clocking type "free oscillating", as the laser diode is continuously active 	
		Sensor		green
	Read Result	green		LED is coupled with the switched output "SWO 2". It indicates the result status selected at the output for the set pulse duration.
		Data		yellow
Percentage evaluation	Sensor Read Result	green	<ul style="list-style-type: none"> lights up constantly due to free-oscillating operation 	
		green		Behaviour depends on reading rate: <ul style="list-style-type: none"> goes out when the reading rate < 30% blinks twice per second when the reading rate is 30% to 70% blinks five times per second when the reading rate is 70% to 90% constant light when the reading rate > 90%
Calibrating help	Sensor	green	<ul style="list-style-type: none"> lights up constantly due to free-oscillating operation 	
Show CP limits	Sensor	green	<ul style="list-style-type: none"> blinks alternately light/dark in the rhythm in which the scan line is partially covered up 	
<p>1) manual check of the parameter set is recommended, e.g. by printing out the whole configuration.</p> <p>2) The blinking goes out at change from read operation to parameterization mode</p>				

Table 8.4: Meaning of the LED indicators: BCL connected to ext. parameter memory. (Cont.)

8.4 Quick Start

When operating on factory default setting, the BCL need not be connected to a PC (except for the first commissioning of the BCL with external parameter memory).

8.4.1 Commission the BCL on Factory Default Setting

1. Connect the BCL with two cables KB 090-3000 No. 500 35319 to the connector unit MA 90.
2. Connect the reading cycle sensor (e.g. retro-reflective photo electric sensor, switch) via MA 90 to the switched input "SE 1" of the BCL (see Section 7.5.6, on page 90).
3. Activate the supply voltage of the MA 90.
The BCL starts operating. The LED "Device Ready" lights up. The output "SWO 1" ("Device Ready") is connected.

BCL with external parameter memory:

If an external parameter memory is connected to the BCL, the LED "Device Ready" blinks about 10 s after a successful start and changes to constant light.

However, if the two LEDs "Device Ready" and "Read Result" blink together continuously, the memory is empty and the BCL is not ready to operate.

Line scanner with oscillating mirror:

In the base setting, the BCL deflects the scan line to both sides of the position CW =50 with a frequency of 1 Hz at an oscillation amplitude of $\pm 20^\circ$ (± 40 CW).

4. Start the reading cycle: cover the light path of the light barrier or turn off switch.
The LED "Sensor" lights up. The BCL switches on the laser diode, the scan line appears.
5. Present the bar code sample from Figure 8.2 to the BCL at the read distance acc. to Table 8.5.
6. Align the bar code in such a way that the red scan line on the bar code is at a near right angle to the code bars (line scanner) or the red scan line sweeps over the code bars at a right angle during deflection (oscillating mirror).
7. Conclude the reading cycle: uncover the light path of the light barrier or turn on switch.
The LED "Sensor" goes off. The BCL turns off the laser diode.
When the reading is successful, the LED "Result" lights up for 100 ms. The output "SWO 2" ("Good Read") is activated for 100 ms.

The BCL is ready for operation on factory default setting.

The device can be switched off without deleting the configuration data since no changes have been made to the parameter set.



Figure 8.2: Bar code sample (Code 39; 0.35 mm; print ratio 2:1)

Device model	Scan technology	Read distance
BCL 90 (all models)	Line scanner	around 1000 mm
	Line scanner with oscillating mirror	around 1000 mm

Table 8.5: Read distance in basic setting

8.5 Configuration (Parameterization)

The BCL is adapted to the reading conditions on site through configuration. Reading, evaluation and output characteristics can be parameterized as needed. The starting point for this is the factory default setting or a BCL parameter set which is already generated and defined according to application.

The BCL offers two configuration procedures:

- Configuration with the PC software BCL-Config
(Setting parameter values via the serial interface)
- Configuration with command strings
(Setting parameter values via the serial interface)

In the parameterization mode, the BCL does not output any read results.

8.5.1 Configure the BCL with User Interface of BCL-Config

When using the software BCL-Config, a PC has to be connected and the software installed in the PC. The connection of the PC to the BCL is described in Section 7.5.5, on page 90.

Transfer the Parameter Set between BCL-Setup and the BCL

BCL-Config operates in off-line mode during the parameterization of the BCL. In order to be able to modify the current parameter set of the BCL, the parameter set has to be loaded from the BCL into BCL-Config first. This process is called **uploading**. BCL-Config always uploads a copy of the current parameter set from the BCL. The current parameter set remains unchanged until it is overwritten by BCL-Config.

Changes made to the current parameter set in BCL-Config does not become effective until after being transferred to the BCL. BCL-Config always loads a copy of the complete parameter set down to the BCL, i.e. all parameter values up to now are overwritten in the BCL. The transfer and storage of the parameter values into the BCL is called **downloading**.

8.6 Oscillating-Mirror Functions

1. Operating mode "oscillating at predefined amplitude"

The oscillating mirror deflects the scan line up to a maximum deflection width of ± 40 CW (equivalent to $\pm 20^\circ$). Figure 8.3 shows an overview of reading from the top.

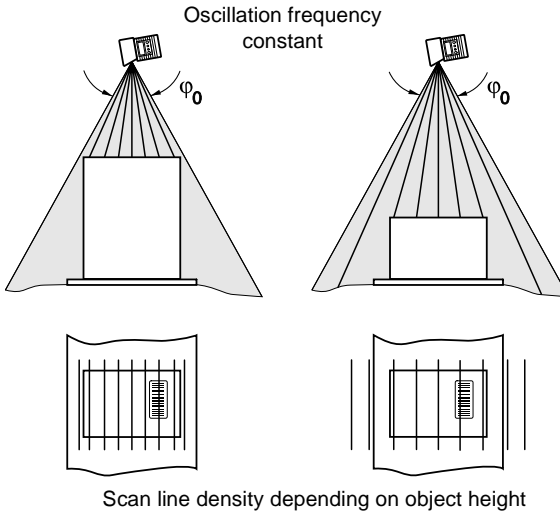

Figure 8.3: Oscillating mirror operating mode "oscillating at predefined amplitude"

2. Operating mode "oscillating at variable amplitude"

The deflection is randomly adjustable for each of the max. 8 distance configurations/focus positions separately. Limiting the oscillation range ensures that the scan line sweeps only relevant areas in which there are bar codes in the short time available in rapid applications. At the same time, this allows the scan line density on the object to remain nearly constant. Figure 8.4 shows the application of a reading from the top.

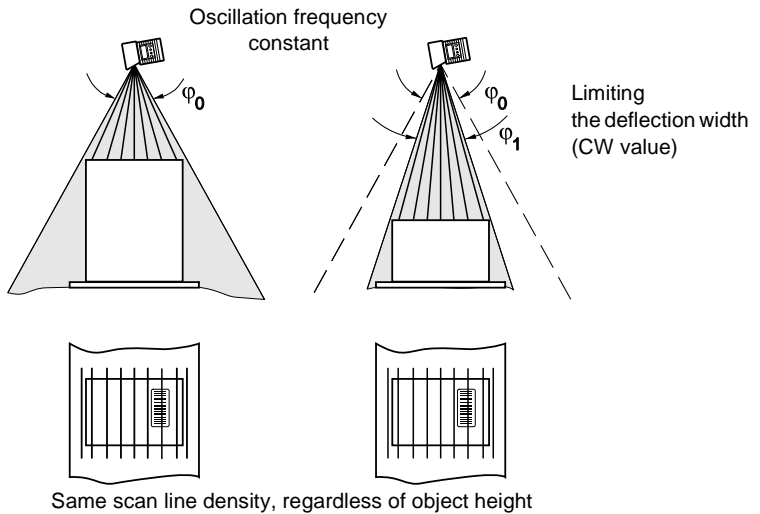

Figure 8.4: Oscillating mirror operating mode "oscillating at variable amplitude"

3. Operating mode "predefined position"

The BCL parks the oscillating mirror at the desired position. In this position, 10 CW corresponds to -20° , 90 CW, on the other hand, $+20^\circ$ (See figure 6.8 on page 74). The predefined position in the base setting is 50 CW (corresponds to 0°). The oscillation operation is switched off.

4. Operating mode "one-shot"

In one-shot, the oscillating mirror performs only one single specific oscillation for each scan gate time. The movement consists of a forward and a return phase. For the oscillation, the starting position of the scan line, the deflection speed and the valid distance configuration can be parameterized separately for each phase. The end position of one of the phases always forms the starting position of the other phase. Figure 8.5 shows an example for the application in object tracking. The front side of the object moving towards the oscillating mirror is scanned once from top to bottom by the scan line during the forward phase at a speed corresponding to that of the transport. A multiple switching of the focus position is omitted as the required DOF is much smaller than that of a line scanner. In Section 9.1.2, on page 113, the calculation of the starting position and of the deflection speeds at given transport speed is described.

The following can be triggers for the one-shot:

- switched input "SE 5" or "SE 6"
- a command string (via the serial interface)
- the start of the scan gate time by the BCL

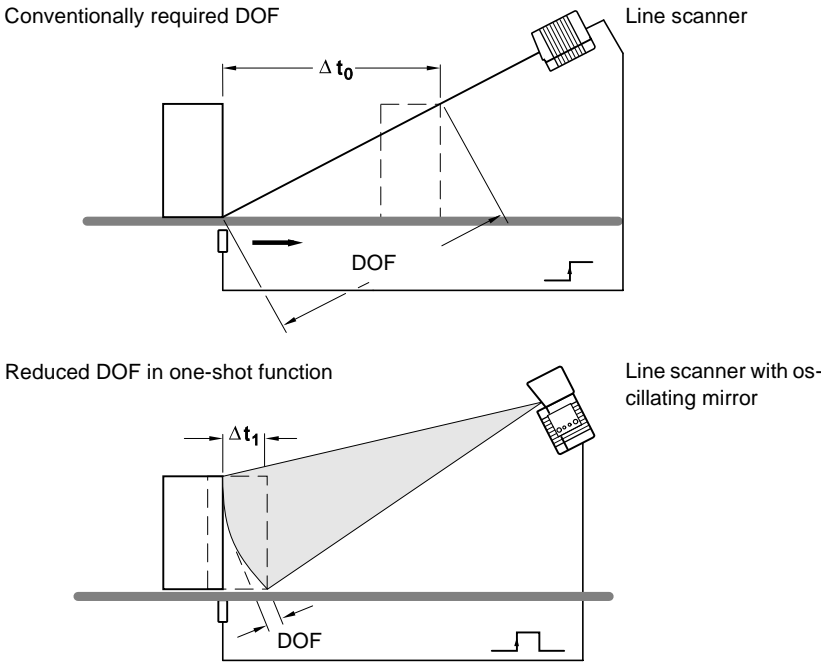

Figure 8.5: One-shot: object tracking (front-side reading)

8.7 Operating Modes and Output of the Read Result

In BCL-Config, the following operating modes/functions can be selected for the BCL:

Standard operating mode:

- Read operation

For commissioning:

- Percentage evaluation
- Calibrating help

For adapting to reading conditions:

- Parameterization (configuration). See Section 8.5.1, on page 103
- Background teach-in
- Show CP limits

For monitoring/troubleshooting:

- Self test

8.7.1 Read Operation (Standard Operating Mode)

The BCL performs a self test after being switched on. The LED "Device Ready" lights up and signals the start of the read operation. In the base setting, the switched input "SE 1" is the (external) trigger of the reading cycle. The BCL outputs the read result via the host and service interfaces.

The read result of the service interface can be displayed in the terminal emulator of BCL-Config. Prerequisite for the display is that the service interface of the BCL is in the mode "read diagnosis". This mode is selected as base setting. The read result of the service interface has a permanent, unalterable format.

Line scanner with oscillating mirror:

In the base setting and in read operation, the BCL deflects the scan line to both sides of the position CW =50 with a frequency of 1 Hz at a max. angle of ± 20 . 50 CW corresponds to a light exit angle smaller than 105°.

Successful read (Good Read):

```
T T= __170 ms MG=_11% n=_1 DC=1
0123412345
C39 100% ST=0 CL=10 CP=_48 CD=_385 CS=_20 CA=_20 CK=_20 DI= R
```

with:

1st line: T T = duration of the scan gate time
 MG = time mean value of the identification rate
 n = number of identified codes
 DC = sequence number of the distance configurations used ¹⁾

2nd line: 0123412345 = data content of the bar code

3rd line: C39 = ID: code type Code 39
 100% = identification rate
 ST = read status (ST=0: Good Read)
 CL = code length (number of characters)
 CP = code position
 CD = code distance (radially from the BCL to the bar code) in mm
 CS = code reliability
 CA = scanning effort
 CK = code continuity
 DI = decoding direction (F= in the scanning direction, R= against the scanning direction)

1) irrelevant for the autofocus function

Figure 8.6: Read result of the service interface: structure for Good Read

No Read

```
T T= __190 ms  MG=_11%  n=_0  DC=1
no code!
```

with:

1st line: T T = duration of the scan gate time
 MG = time mean value of the identification rate
 n = number of identified codes
 DC = sequence number of the distance configurations used ¹⁾

2nd line: no code! = no bar code found!

1) irrelevant for the autofocus function

Figure 8.7: Read result of the service interface: structure for No Read

**Notice!**

The BCL outputs several bar codes in the read result only when the parameterized min. and max. numbers of bar codes are > 1 and the BCL is presented with several bar codes.

8.7.2 Percentage Evaluation

In percentage evaluation, the quality of the bar code readings are assessed which are taken up in the reading field of the BCL as static codes (no transport movement).

In free-oscillating operation, the BCL performs 100 scans and assesses the reading rate. It outputs the read results continuously every 2 s via the terminal interface. The read results can be displayed in the terminal emulator of BCL-Config.

For percentage evaluation, it is necessary to switch temporarily to the standard decoder.

Line scanner with oscillating mirror:

In percentage evaluation, the BCL switches off the oscillation operation (base setting: oscillating at predefined amplitude) and positions the scan line under the angle CW=50 (corresponds to a light exit angle smaller than 105°). The angle cannot be changed.

The indication of the LED "Read Result" presents additional optical information on the reading rate achieved:

- The LED goes out when the reading rate < 30%
- The LED blinks twice per second when the reading rate is 30% to 70%
- The LED blinks five times per second when the reading rate is 70% to 90%
- The LED lights up constantly when the reading rate > 90%

8.7.3 Calibrating help

The operating mode calibrating help permits the optimum positioning of the middle of the scan line on the bar code. In this mode, the BCL does not output any read results.

Line scanner with oscillating mirror:

In the calibrating help mode, the BCL switches off the oscillation operation (base setting: oscillating at predefined amplitude) and positions the scan line under the angle $CW=50$ (corresponds to a light exit angle smaller than 105°). The angle cannot be changed.

8.7.4 Background Teach-in

When the autofocus function is operated in the mode "difference to background" or "Difference to background with tracking", the BCL first has to learn the **background** in its field of view before a successful read can be performed. When generating the internal distance profile, **no reading object** may be within the field of view of the BCL. In this mode, the BCL does not output any read results.

Line scanner with oscillating mirror:

In background teach-in, the BCL switches off the oscillation operation (base setting: oscillating at predefined amplitude) and positions the scan line under the angle $CW=50$ (corresponds to a light exit angle smaller than 105°). The angle cannot be changed.

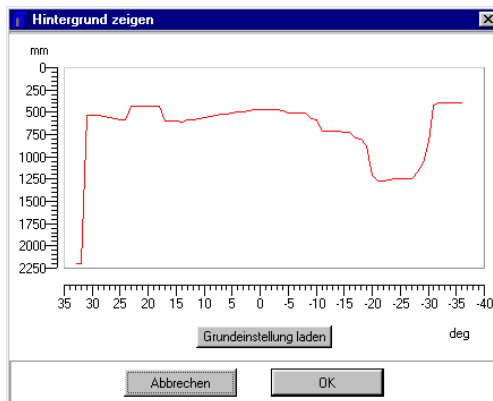

Figure 8.8: BCL-Config: display of the learned background

8.7.5 Self Test

After being switched on, the device runs a self test before the initialisation with the parameter set. In the self test, the BCL checks the proper functioning of its hardware components. Finally, a report on the test result is sent through the terminal interface. During the test routine, the BCL does not output any read results.

The code number "15000" means that the self test has been concluded successfully and no defect has been diagnosed.

9 Configuration

9.1 Calculating of Parameter Values for Setting the BCL

9.1.1 Calculating the Number of Scans (for Standard Decoder)

The maximum number of scans for a bar code depends on the transport speed.

Line scanner: ladder-type bar codes

Line scanner: lateral reading of object

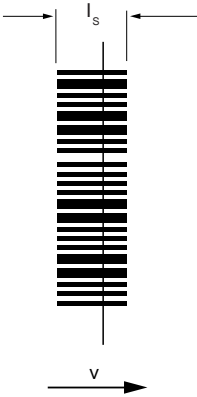

Calculations for standard decoder!

$$v = \frac{s}{t}$$

$$v = \frac{l_s}{n \cdot t_{\text{scan}}} \quad t_{\text{scan}} = \frac{1}{f}$$

$$v = \frac{l_s}{n} \cdot f$$

$$n = \frac{l_s}{v} \cdot f$$

Specifications:

Number of scans $n = ?$

Transport speed $v = 1.5 \text{ m/s}$

Code length $l_c = 20 \text{ mm}$

Scanning frequency $f = 600 \text{ Hz}$

Bar code 100% reading rate

$$n = \frac{0,02\text{m}}{1,5\frac{\text{m}}{\text{s}}} \cdot \frac{600}{\text{s}} \quad \mathbf{n = 8}$$

Figure 9.1: Line scanner: calculation example of the number of scans for ladder-type bar codes

Line scanner: fence-type bar codes

Line scanner: lateral reading of object

Calculations for standard decoder!

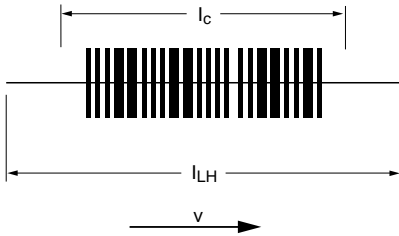

$$v = \frac{s}{t}$$

$$v = \frac{(l_{LH} - l_c)}{n \cdot t_{scan}} \quad t_{scan} = \frac{1}{f}$$

$$v = \frac{(l_{LH} - l_c)}{n} \cdot f$$

Specifications:

Number of scans $n = ?$

Transport speed $v = 2 \text{ m/s}$

Code length with quiet zone $l_c = 150 \text{ mm}$

Reading field height $l_{LH} = 400 \text{ mm}$

Scanning frequency $f = 600 \text{ Hz}$

Bar code 100% reading rate, all scans on the code

Code window $s = l_{LH} - l_c$

$$n = \frac{(l_{LH} - l_c)}{v} \cdot f$$

$$n = \frac{(0,4 - 0,15) \text{ m}}{2 \frac{\text{m}}{\text{s}}} \cdot \frac{600}{\text{s}} \quad n = 75$$

Figure 9.2: Line scanner: calculation example of the number of scans for fence-type bar codes

Line scanner with oscillating mirror: fence-type bar codes

Line scanner with oscillating mirror: lateral reading of object

Calculations for standard decoder!

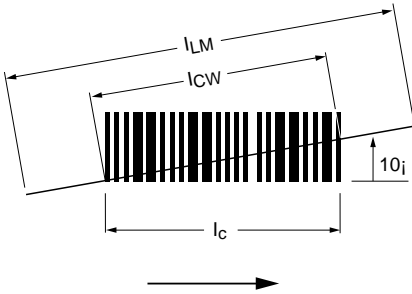

Specifications:

- Number of scans $n = ?$
- Transport speed $v = 0.5 \text{ m/s}$
- Code length with quiet zone $l_c = 100 \text{ mm}$
- Code length under 10° $l_{cw} = \frac{100\text{mm}}{\cos 10^\circ} = 102\text{mm}$
- Reading field height $l_{LH} = 500 \text{ mm}$
- Scanning frequency $f = 600 \text{ Hz}$
- Bar code 100% reading rate, all scans on the code
- Code window $s = l_{LH} - l_c$

1. Dwell time of the bar code in the reading field:

$$t = \frac{s}{v}$$

$$t = \frac{(l_{LH} - l_{cw})}{v}$$

$$t = \frac{(0,5 - 0,102)}{0,5 \frac{\text{m}}{\text{s}}}$$

$$t = 796\text{ms}$$

2. Required oscillating mirror frequency:

$$f_{sw} = \frac{1}{t}$$

$$f_{sw} = \frac{1}{0,796\text{s}}$$

$$f_{sw} = 1,26\text{Hz}$$

3. Number of possible scans (rough estimation):

$$n = \frac{f}{f_{sw}}$$

$$n = \frac{600\text{Hz}}{1,26\text{Hz}}$$

$$n = 476$$

Figure 9.3: Line scanner with oscillating mirror: calculation example of the number of scans for fence-type bar codes

9.1.2 Calculating the Starting Position and Deflection Speed for the Forward and Return Phase of the One-Shot

Line scanner with oscillating mirror

Theoretical study: frontal reading (object moves towards the BCL)

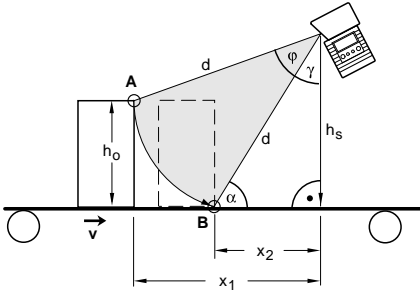

(Scanning direction in the drawing plane)

Data:

- h_o = max. object height
- h_s = distance of the BCL above the transport level
- φ = oscillation angle
- α = max. contact angle on the bar code (skew)
- Starting phase 1: point A
- Starting phase 2: point B

Specifications:

- $h_s > h_o / \alpha \leq 45^\circ$ (better: $\alpha \leq 30^\circ$)
- max. deflection angle setting: $\pm 20^\circ$
- Determine distances by making measurements:
 - x_1 = distance at starting phase 1
 - x_2 = distance at starting phase 2

1. Focus position for distance configuration: 3. Deflection speed φ^* :

$$\sin \alpha = \frac{h_s}{d} \Rightarrow d = \frac{h_s}{\sin \alpha}$$

$$v = \frac{\Delta x}{\Delta t}; \Delta x = x_1 - x_2$$

2. Oscillation angle φ :

$$\varphi^* = \frac{\Delta \varphi}{\Delta t}$$

$$\gamma = 90^\circ - \alpha$$

The oscillating mirror has to cross the angle $\Delta \varphi$ in the same time Δt , in which the object moves from x_1 to x_2

$$\cos(\varphi + \gamma) = \frac{(h_s - h_o)}{d}$$

$$\frac{\Delta x}{v} = \frac{\Delta \varphi}{\varphi^*}$$

$$\varphi = \arccos\left(\frac{(h_s - h_o)}{d}\right) - \gamma$$

$$\varphi^* = \Delta \varphi \cdot \frac{v}{\Delta x} \text{ mit } 1^\circ / \text{s} = 2 \text{ CW} / \text{s}$$

• enter φ symmetrically to CW=50:

When entering the values please note:

$$\text{StartPos1} = 50 \text{ CW} + \left(\frac{\varphi}{2} \cdot \frac{1 \text{ CW}}{0,5^\circ}\right)$$

- Debouncing time of the switched input for the one-shot
- Starting time of the oscillating mirror (mass acceleration)

$$\text{StartPos2} = 50 \text{ CW} - \left(\frac{\varphi}{2} \cdot \frac{1 \text{ CW}}{0,5^\circ}\right)$$

- Select the deflection speed of the return phase, depending on the distances between the objects, in such a way that the scan line returns to the starting position (point A) in time.
- Check the values determined in theory on location and make adjustments as required

Figure 9.4: One-shot line scanner with oscillating mirror: calculating the number of scans for fence-type bar codes

9.1.3 Calculating Required Distances between Bar Codes for Reading Several Bar Codes per Object



CRT decoder:

For bar codes with identical code types and identical or varying data contents.

Distance dx: min. 60 x module width
 e.g. 30 mm for module width 0.5 mm

Distance dy: 10 x d_{scan}
 with d_{scan} = vertical distance between two subsequent scan lines

e.g. scan line 90° to the bar code, scanning frequency 800 Hz, $v = 2$ m/s

$$d_{scan} = \frac{v}{f} \quad d_{scan} = \frac{2000\text{mm/s}}{800/\text{s}} = 2,5$$

$$dy = 10 \cdot 2,5\text{mm} = 25\text{mm}$$

Standard decoder

The above distances are also required when the same bar codes (identical data contents and identical code types) are to be read.

Condition for separating same bar codes:

1. correct parameterization of "code distance" between the bar codes
2. activate code position comparison

Bar code lines in the direction of transport:

When the scan line detects the same bar codes with the same code positions, an external incremental encoder or an internal INC timer is needed for the path length information to separate the bar codes .

Rule of thumb: the bar code should be surrounded by quiet zones!

Figure 9.5: Required distances between the bar codes on an object

9.2 Overview of Commands and Parameters

Online commands can be used to send commands directly to the device for control and configuration.

For this, the BCL 90/MA 90 or BCL 90 has to be connected to a host or service computer via the serial interface. The commands described can be sent either via the host or the service interface.

The on-line commands enable you to:

- control/decode.
- copy parameters.
- carry out a software reset in order to reinitialise the device.

Syntax

"Online" commands consist of one or two ASCII codes, followed by command parameters.

No separation characters may be entered between the command and the command parameter(s). Both small and capitalised letters can be used.

Example:

Command **'PC'**: Copy parameters

Parameter **'20'**: Parameter default

The signal sent: **'PC20'**

Spelling conventions

Commands, command parameters and returned data in the text are enclosed between single quotation marks 'x'.

Most "online" commands are acknowledged by the BCL 90 or requested data are sent back. For commands that are not acknowledged, command execution can be observed or monitored directly on the device.

9.2.1 General 'Online' Commands

Software version number

Command	'V'
Description	Requests device version information
Parameter	no
Acknowledgement	'BCL 90 V 01.00 08.01.1999' The first line contains the scanner model, followed by device version number and date of version. (The data which are actually displayed may vary from the values given here.)



Notice!

This command allows you to check whether a host or service computer is correctly connected and configured. If you do not receive an acknowledgement, please check interface connections, protocol and service switches.

Software reset

Command	'H'
Description	Carries out a software reset. The device is restarted and reinitialised, leaving it in the same state as when the supply voltage is switched on.
Parameter	no
Acknowledgement	'S' (start signal)

9.2.2 'Online' Command for System Control

Activate sensor input 1

Command	'+'
Description	The command activates decoding.
Parameter	no
Acknowledgement	no

Deactivate sensor input 1

Command	'-'
Description	The command deactivates decoding.
Parameter	no
Acknowledgement	no

Copy parameter set

Command	'PC'
Description	The command copies complete parameter sets.
Parameter	'20' copy standard parameters from the FLASH into the EEPROM and RAM and initialise all relevant functions
Acknowledgement	'PSx' x: status '000' command successfully executed '001' general error in loading the default values or in writing in the internal EEPROM parameter memory

9.3 Installation of the "BCL-Config" software

- Insert the installation diskette into your disk drive.
- Call up the installation file (e.g. Setup.exe)

The following window appears:



Figure 9.6: Installation window

- Confirm the following licence agreement and select the installation path in the following window:

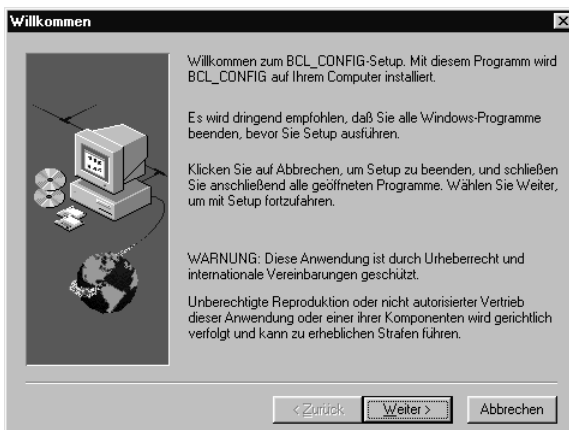

Figure 9.7: Installation directory

- Confirm your entry with "Continue" and follow the installation routine.

For further details please refer to online help of the "BCL-Config" software

10 Maintenance

10.1 Servicing during Operation

In order to maintain its full reading capability, the BCL needs a clean reading window. We therefore recommend checking regularly whether the reading window is dirty, particularly in rough operating environment (dust, abraded particles, humidity, finger prints).



Damage to the eyes through laser radiation!

The BCL operates with a red light laser of Class 2. Staring at the laser beam may cause damage to the retina.

- Never look at the laser beam directly (same as sunlight).
- Turn off device during cleaning
- Avoid looking at the reading window at all times during device operation



Damage to the reading window!

The reading window is made of glass. The reading capacity is reduced through scratches and streaks on the reading window.

- Use mild detergents without powder additives
- Avoid scratching and scrubbing motions on the reading window

Cleaning the reading window:

- Clean the reading window in regular intervals with a mild detergent without powder additives, e.g. an antistatic window cleaning detergent. Figure 10.1 shows the areas to be cleaned. Use a soft, lintfree cleaning cloth.

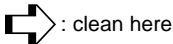

frontal reading window

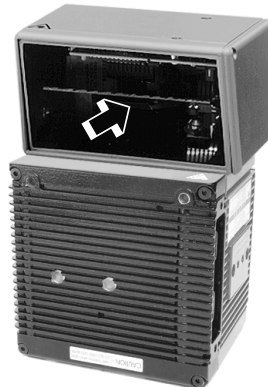

lateral reading window

Figure 10.1:Cleaning the reading window

- Also clean the LED indicator at the back of the device as required.

Clean other, optically relevant surfaces:

- Also clean the optical surfaces of sensors (e.g. retro-reflective photo electric sensors) for external reading cycle generation and/or object height detection (Figure 10.2). Fouling may cause erroneous switching.

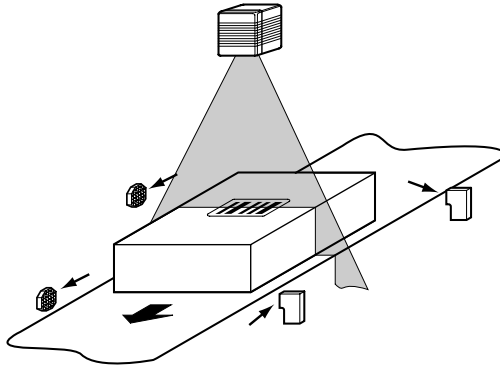

Figure 10.2:Cleaning the external optical sensors (reading cycle clock generator, object height detection)

10.2 Maintenance

The BCL runs without maintenance. Its self-monitoring functions provide for a long operation free of failures.

The BCL outputs device and functional disorders in the form of messages via the service interfaces. These can be displayed on the PC screen in the extended mode of the terminal emulator of the user interface of BCL-Config.

10.3 Repairs, Servicing

Only the manufacturer may repair the devices

- For repairs please turn to the your Leuze sales or service outlets. You will find the addresses at the back of this description