

**KRTM 3B**

**Multicolor contrast scanner**

en 05-2011/04 50110625-02



**Dimensioned drawing**

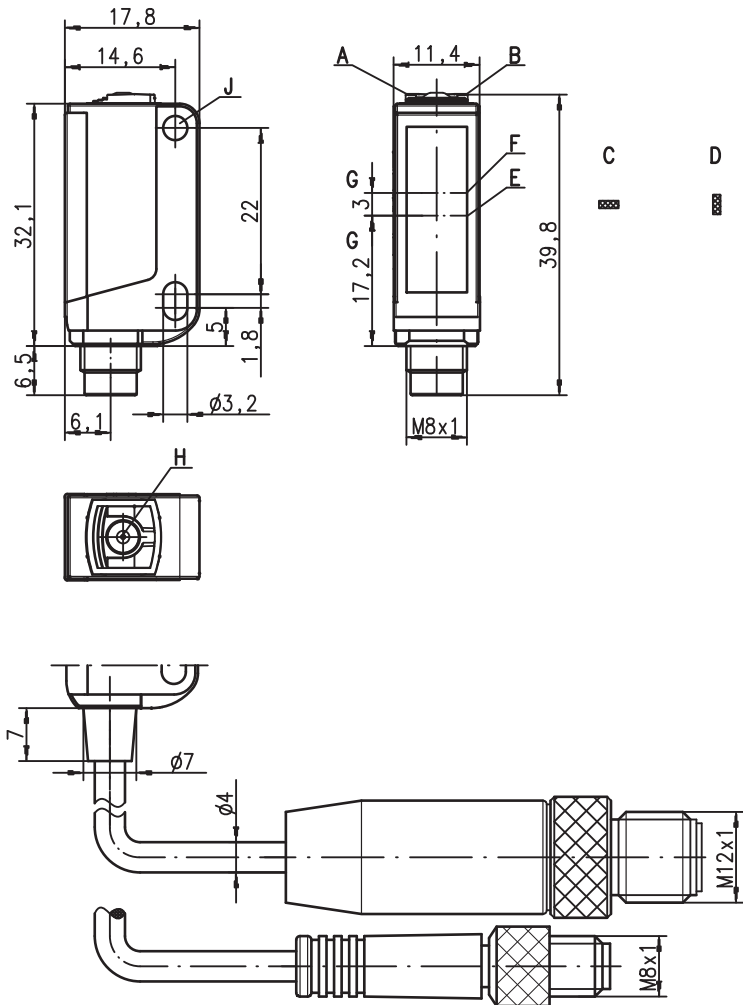

- A Green indicator diode
- B Yellow indicator diode
- C Light spot orientation horizontal
- D Light spot orientation vertical
- E Transmitter
- F Receiver
- G Optical axis
- H Teach button
- J Attachment sleeve

**14.5mm**



- RGB transmitter
- Various teach variants
- Short response time
- Switching threshold adjustment via EasyTune
- Level adaptation for glossy objects
- Keyboard lockout
- Remote teach via cable
- Pulse stretching 20ms

**Electrical connection**

Plug connection, 4-pin

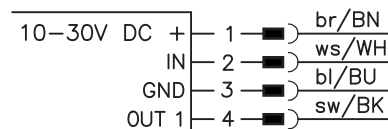

**Accessories:**

(available separately)

- Mounting systems (BT 3...)
- Cable with M8 or M12 connector (K-D ...)

We reserve the right to make changes • DS\_KRTM3B\_en.fm



## Specifications

### Optical data

Scanning range <sup>1)</sup>		14.5mm ± 2mm
Light spot dimensions	in RUN-Mode	1.5mm x 4mm (at a distance of 14.5mm)
	in Teach-Mode	1.5mm x 6.5mm (at a distance of 14.5mm)
Light spot orientation		vertical or horizontal (see dimensioned drawing)
Light source <sup>2)</sup>		LEDs (red, green, blue)
Wavelength		640nm, 525nm, 470nm

### Sensor operating modes

IO-Link	COM2 (38.4kBaud)
SIO	standard push-pull
Dual Core	no

### Timing of the sensor

Internal switching frequency	10kHz
Internal response time	50µs
Response jitter, internal	20µs
Repeatability <sup>3)</sup>	0.02mm
Delay before start-up	≤ 300ms
Conveyor speed during teach	≤ 0.1 m/s for a mark width of 1 mm
Teach process	static 1-point, static 2-point or dynamic 2-point
Teach delay	≤ 10ms

### Timing of the outputs

Response time	Pin 4	IO-Link COM2: acc. to IO-Link specification (typically 2.5ms)
		SIO: 50µs

### Electrical data

Operating voltage $U_B$ <sup>4)</sup>	with SIO	10 ... 30VDC (incl. residual ripple)
	with COM2	18 ... 30VDC (incl. residual ripple)
Residual ripple		≤ 15% of $U_B$
Output/function	.../2...	pin 4: GND if mark detected
	.../4...	pin 4: $U_B$ if mark detected
	.../6...	pin 4: IO-Link SIO mode, $U_B$ if mark detected
	.../6...	pin 4: IO-Link COM2 mode, see configuration file IODD
Signal voltage high/low		≥ ( $U_B - 2V$ ) / ≤ 2V
Output current		max. 100mA
Open-circuit current		≤ 25mA

### Indicators

Green LED in continuous light	ready
Green and yellow LED flashing at 3Hz	teach event active
Green and yellow LED flashing at 8Hz	teaching error
Green LED off and yellow LED flashing at 8Hz	sensor error
Yellow LED in continuous light	mark detected (dependent on the teach sequence)
Transmitter LEDs flashing at 8Hz	teaching error

### Mechanical data

Housing <sup>5)</sup>	plastic (PC-ABS), with attachment sleeve, nickel-plated steel
Optics cover	plastic (PMMA)
Weight	10g
Connection type	M8 connector, metal

### Environmental data

Ambient temp. (operation/storage)	-30°C ... +55°C / -30°C ... +70°C
Protective circuit <sup>6)</sup>	2, 3
VDE safety class	III
Protection class	IP 67
Light source	free group (in accordance with EN 62471) Light source
Standards applied	IEC 60947-5-2
Certifications	UL 508 <sup>4)</sup>

### Options

<b>Input pin 2</b>	
Function characteristics	keyboard lockout / line teach / pulse stretching
Input active/not active	≥ 8V / ≤ 2V or not connected
<b>Output pin 4</b>	
Line teach active	for SIO 2Hz at the switching output
	for COM2 see configuration file IODD
Error after line teach	for SIO 2Hz at the switching output
	for COM2 see configuration file IODD

- 1) Scanning range: recommended range with performance reserve
- 2) Average life expectancy 100,000h at an ambient temperature of 25°C
- 3) At conveyor speed 1 m/s
- 4) For UL applications: for use in class 2 circuits according to NEC only
- 5) Patent Pending Publ. No. US 7,476,848 B2
- 6) 2=polarity reversal protection, 3=short-circuit protection for all transistor outputs

## Tables

## Diagrams

## Remarks

- **Approved purpose:**  
This product may only be used by qualified personnel and must only be used for the approved purpose. This sensor is not a safety sensor and is not to be used for the protection of persons.
- With glossy objects, the sensor is to be fastened at an inclination of approx. 10° relative to the object surface.

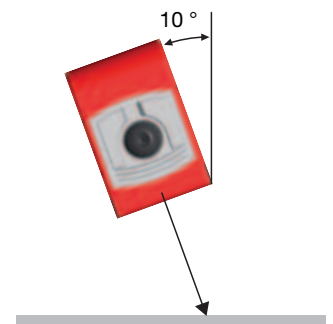

# KRTM 3B

# Multicolor contrast scanner

## Order guide

Selection table		Order code →									
Equipment ↓		KRTM 3B/6.1121-S8 Part no. 50111312	KRTM 3B/4.1121-S8 Part no. 50110584	KRTM 3B/4.1221-S8 Part no. 50110588	KRTM 3B/2.1121-S8 Part no. 50110585	KRTM 3B/4.1121,200-S12 Part no. 50110586	KRTM 3B/2.1121,200-S12 Part no. 50110587	KRTM 3B/2.1221-S8 Part no. 50110589	KRTM 3B/4.1221,200-S12 Part no. 50110590	KRTM 3B/2.1221,200-S12 Part no. 50110591	
Transmitter color	white light										
	RGB (red, green, blue)	•	•	•	•	•	•	•	•	•	
	laser-generated red light										
Light spot orientation	vertical	•	•	•	•	•	•	•	•	•	
	horizontal										
	round										
Output (OUT 1)	PNP transistor output		•	•		•			•		
	NPN transistor output				•		•	•		•	
	push-pull switching output	•									
	IO-Link COM2	•									
Input (IN)	teach input	•	•	•	•	•	•	•	•	•	
Housing	standard	•	•	•	•	•	•	•	•	•	
	economy										
Connection	M8 connector, metal	•	•	•	•			•			
	M8 connector, plastic										
	200 mm cable with M12 connector					•	•		•	•	
Teach-in method	static 1-point										
	static 2-point	•	•		•	•	•				
	dynamic 2-point			•				•	•	•	
Response time / Switching frequency	50µs / 10 kHz	•	•	•	•	•	•	•	•	•	
	83µs / 6 kHz										
	125µs / 4 kHz										
Configuration	switching threshold adjustment with EasyTune via teach button	•	•	•	•	•	•	•	•	•	
	remote teach, keyboard lockout and pulse stretching via pin 2	•	•	•	•	•	•	•	•	•	
	teach level 1, teach-level 2 and pulse stretching via teach button	•	•	•	•	•	•	•	•	•	

## IO-Link process data

The sensor transmits 2 bytes to the master.

Data bit																Assignment	Default settings
15	14	13	12	11	10	9	8	7	6	5	4	3	2	1	0		
																Switching output	0 = no mark, 1 = mark detected
																Not used	Free
																Sensor operation	0 = off, 1 = on
																Switching threshold LSB	Value range 0 ... 31 (0 ... 100% in approx. 3% steps)  0% = min. switching threshold 100% = max. switching threshold
																Switching threshold	
																Switching threshold	
																Switching threshold	
																Switching threshold MSB	
																Active transmitter LSB	00 = red, 01 = green or white,
																Active transmitter MSB	10 = blue, 11 = all colors on (teach-in active)
																Not used	Free
																Measurement value LSB	Value range 0 ... 31 (0 ... 100% in approx. 3% steps)  0% = min. signal level 100% = max. signal level
																Measurement value	
																Measurement value	
																Measurement value	
																Measurement value MSB	





Additional information on the IO-Link service data is available on request.



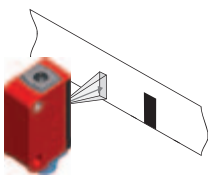
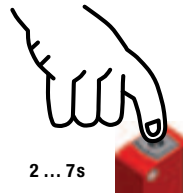
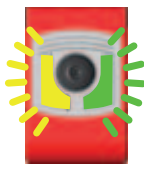
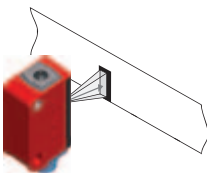
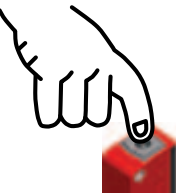

## Static 2-point teach

Suitable for manual positioning of the marks (availability dependent on sensor type).

### Switching threshold in center:

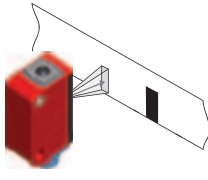
Position the background. 	Press teach button for 2 ... 7s and release.  2 ... 7s Value for background is accepted.	LEDs flash simultaneously.  Simultaneous flashing	Position the mark. 	Briefly press teach button.  Value for mark is accepted.	Sensor in RUN mode. Yellow LED illuminates.  Switching threshold set in the center.
---	--	--	---	---	--

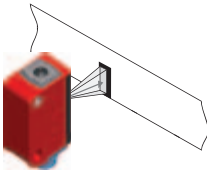
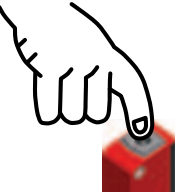
### Switching threshold near the mark:

Position the background. 	Press teach button for 7 ... 12s and release.  7 ... 12s Value for background is accepted.	LEDs flash alternatingly.  Alternating flashing	Position the mark. 	Briefly press teach button.  Value for mark is accepted.	Sensor in RUN mode. Yellow LED illuminates.  Switching threshold is set near the mark.
---	--	--	---	---	---





**KRTM 3B**

**Multicolor contrast scanner**



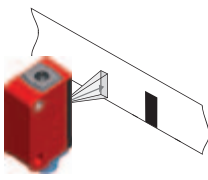
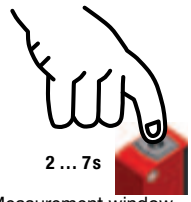

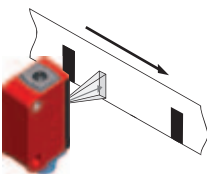
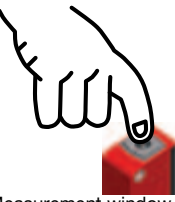
**Dynamic 2-point teach**

Suitable for marks moved during automated machine processes (availability dependent on sensor type).

**Switching threshold in center**

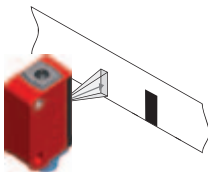
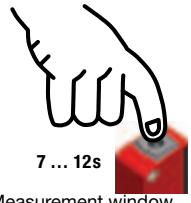
<p>Position the background.</p> 	<p>Press teach button for 2 ... 7s and release.</p> <p>2 ... 7s</p>  <p>Measurement window opens.</p>	<p>LEDs flash simultaneously.</p>  <p><b>Simultaneous flashing</b></p>	<p>Allow marks to pass through dynamically.</p> 	<p>Briefly press teach button.</p>  <p>Measurement window closes.</p>	<p>Sensor in RUN mode. Yellow LED is off.</p>  <p>Switching threshold set in the center.</p>
---	--	---	---	--	---

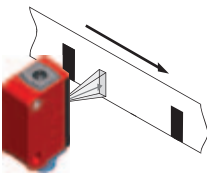
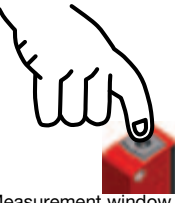

**Switching threshold near the mark**

<p>Position the background.</p> 	<p>Press teach button for 7 ... 12s and release.</p> <p>7 ... 12s</p>  <p>Measurement window opens.</p>	<p>LEDs flash alternatingly.</p>  <p><b>Alternating flashing</b></p>	<p>Allow marks to pass through dynamically.</p> 	<p>Briefly press teach button.</p>  <p>Measurement window closes.</p>	<p>Sensor in RUN mode. Yellow LED is off.</p>  <p>Switching threshold is set near the mark.</p>
---	--	---	---	--	--



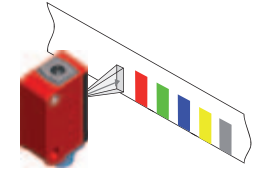
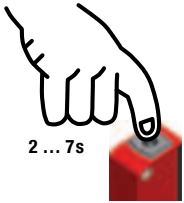
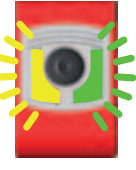
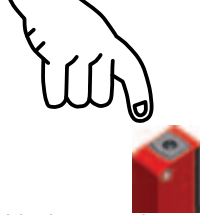

**Static 1-point teach**

Suitable for detecting all marks outside of the reference value (availability dependent on sensor type).

**Standard sensitivity**

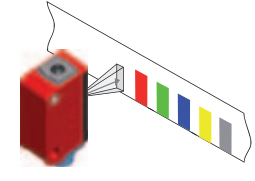
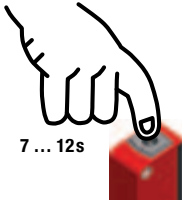
<p>Position the reference value.</p> 	<p>Press teach button for 2 ... 7s.</p> <p>2 ... 7s</p> 	<p>LEDs flash simultaneously.</p>  <p><b>Simultaneous flashing</b></p>	<p>Release teach button.</p>  <p>Value is accepted.</p>	<p>Sensor in RUN mode. Yellow LED is off.</p>  <p>Standard sensitivity is set.</p>
--	---	---	---	---

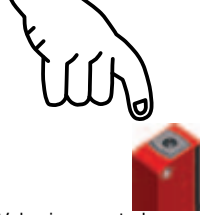
**High sensitivity**

<p>Position the reference value.</p> 	<p>Press teach button for 7 ... 12s.</p> <p>7 ... 12s</p> 	<p>LEDs flash alternatingly.</p>  <p><b>Alternating flashing</b></p>	<p>Release teach button.</p>  <p>Value is accepted.</p>	<p>Sensor in RUN mode. Yellow LED is off.</p>  <p>High sensitivity is set.</p>
--	---	---	---	---

## Switching threshold diagrams

### Static 2-point teach

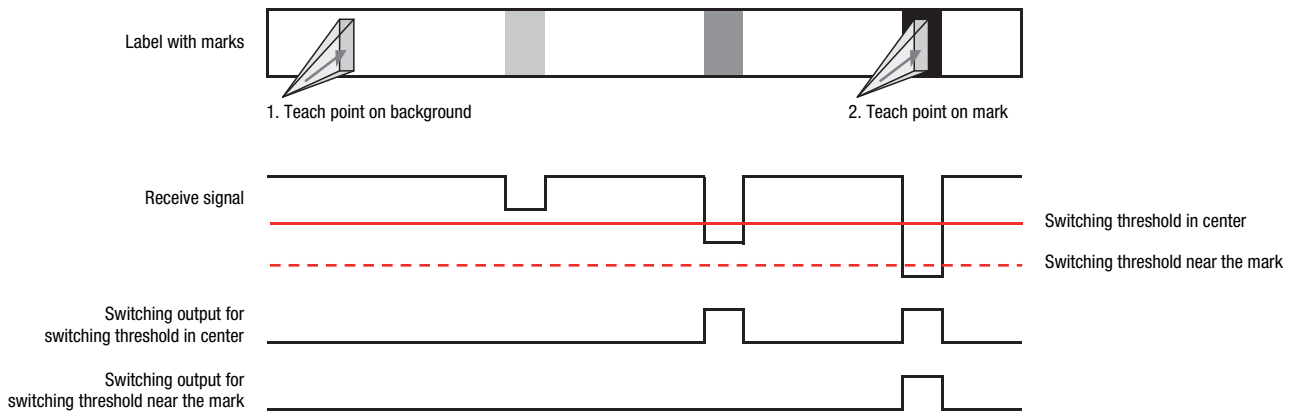

### Dynamic 2-point teach

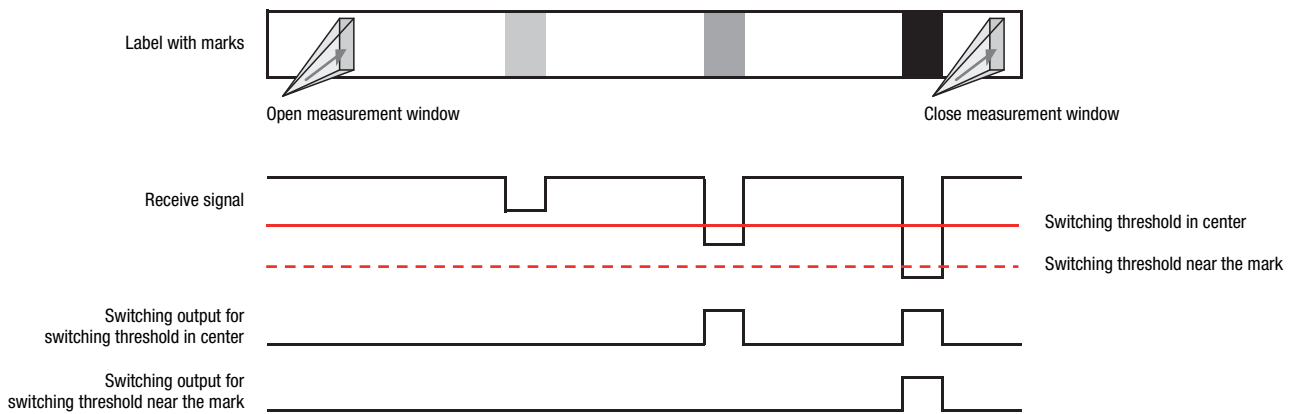

### Static 1-point teach

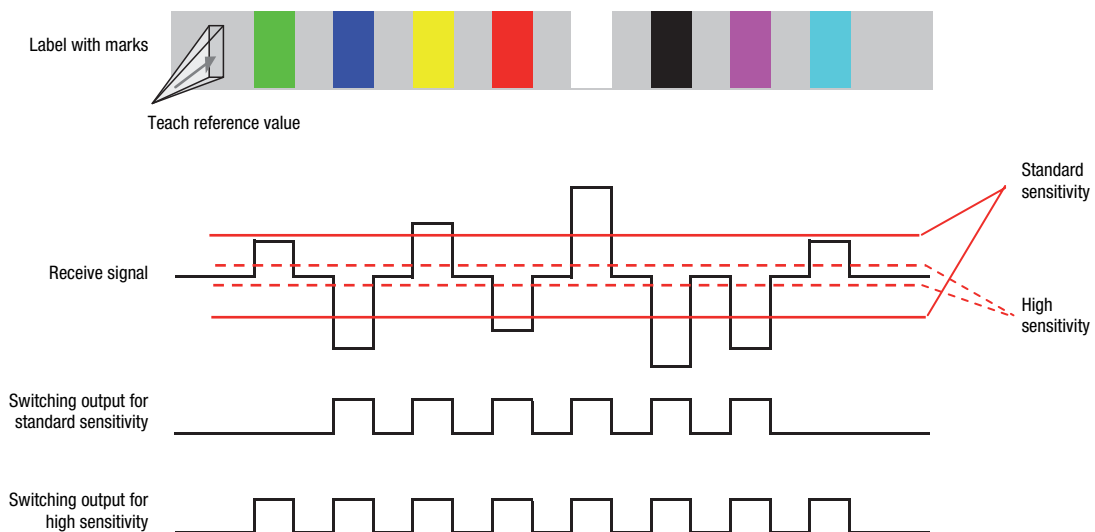



**KRTM 3B**

**Multicolor contrast scanner**

**Pulse stretching option**

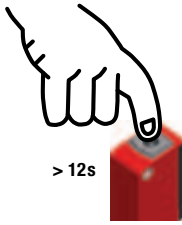
Switching pulse stretching on or off:

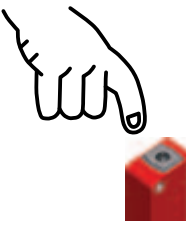
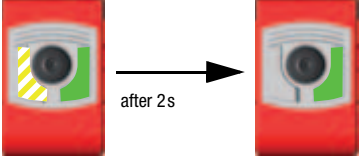

<p>Press the teach button longer than 12s.</p>  <p>&gt; 12s</p>	<p>Only the green LED flashes.</p> 	<p>Release teach button.</p> 	<p>Change is displayed and accepted automatically after 2s. Sensor in RUN mode.</p>  <p>after 2s</p> <p>After 2s the yellow LED is back to normal operation, displaying the state of the switching output.</p> <p>After releasing the teach button, the yellow LED displays the new pulse stretching status for 2s:          yellow LED on: pulse stretching ON          yellow LED off: pulse stretching OFF</p>
--	--	--	---

**"EasyTune" option - fine tuning of the switching threshold**

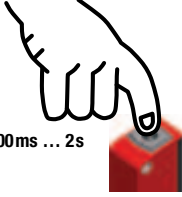

Following power-on and completed teach event:

Green LED illuminates continuously (ready),  
 Yellow LED on/off continuously (mark detected/not detected).

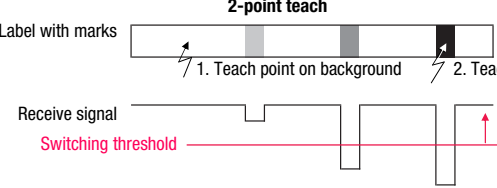
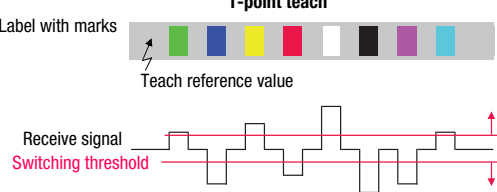
**Increasing the switching threshold:**

<p>Long press of the button = large force expenditure = increase switching threshold</p> <p>Each press of the button with a duration between 200ms and 2s increments the switching threshold.</p>  <p>200ms ... 2s</p>	<p>Green LED flashes briefly once</p>  <p>A press of the button is acknowledged by a single, brief flash of the green LED – the new switching threshold is now valid.</p>	<p><b>2-point teach</b></p>  <p>Label with marks</p> <p>1. Teach point on background 2. Teach point on mark</p> <p>Receive signal</p> <p>Switching threshold</p> <p>Increase the switching threshold</p> <p><b>1-point teach</b></p>  <p>Label with marks</p> <p>Teach reference value</p> <p>Receive signal</p> <p>Switching threshold</p> <p>Increase the switching threshold</p>
---	--	--

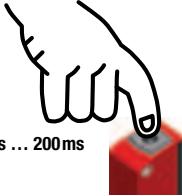
**Reducing the switching threshold:**

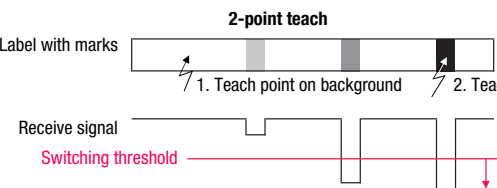
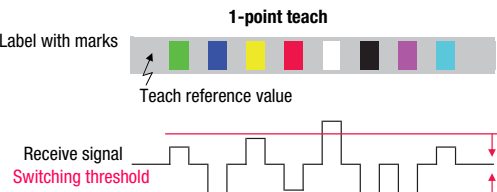
<p>Short press of the button = small force expenditure = reduce switching threshold</p> <p>Each press of the button with a duration between 2ms and 200ms decrements the switching threshold.</p>  <p>2ms ... 200ms</p>	<p>Green LED flashes briefly once</p>  <p>A press of the button is acknowledged by a single, brief flash of the green LED – the new switching threshold is now valid.</p>	<p><b>2-point teach</b></p>  <p>Label with marks</p> <p>1. Teach point on background 2. Teach point on mark</p> <p>Receive signal</p> <p>Switching threshold</p> <p>Reduce the switching threshold</p> <p><b>1-point teach</b></p>  <p>Label with marks</p> <p>Teach reference value</p> <p>Receive signal</p> <p>Switching threshold</p> <p>Reduce the switching threshold</p>
--	--	---



If the upper or lower end of the adjustment range is reached, the green and yellow LEDs flash at a considerably higher frequency of 8Hz for the duration of one second.

### Sensor adjustments via the input IN (Pin 2)



The following description applies to PNP switching logic!

Signal level LOW  $\leq 2V$

Signal level HIGH  $\geq (U_B - 2V)$

With the NPN models, the signal levels are inverted!

#### Switching threshold in center / standard sensitivity

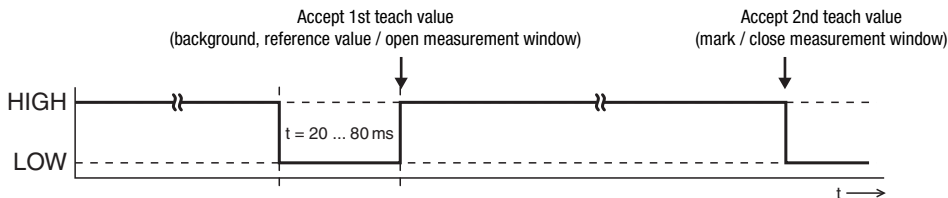

#### Switching threshold near the mark / high sensitivity

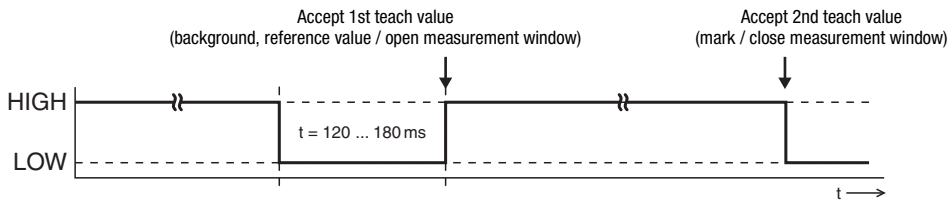

#### Pulse stretching ON

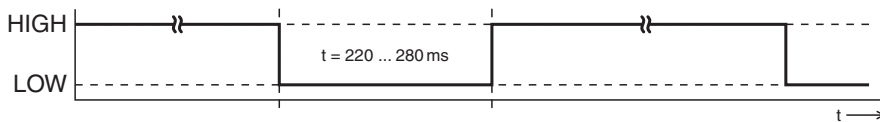

#### Pulse stretching OFF

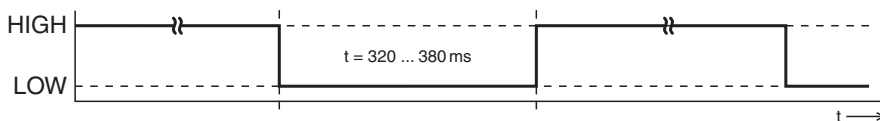

### Locking the teach button via the input IN (Pin 2)



A static HIGH signal ( $\geq 20ms$ ) at the teach input locks the teach button on the sensor if required, such that no manual operation is possible (e.g., protection from erroneous operation or manipulation).

If the teach input is not connected or if there is a static low signal, the button is unlocked and can be operated freely.

